

**BUILDING
MATERIALS**



Ultra High Strength
Consistent
Bricks, Blocks, Pavers



KANKARIA PROPERTIES PVT. LTD.

BRICKS AND BLOCKS

Sr. No.		Pg. No.
1.	INTRODUCTION	3
2.	OUR PRODUCTS	4
3.	PRODUCT FEATURES	5
4.	STRUCTURAL BRICKS	6
5.	NORMAL BRICKS	8
6.	FROG BRICKS	10
7.	BIG FROG BRICKS	11
8.	390X190X90 mm SOLID BLOCKS	12
9.	400X200X150 mm SOLID BLOCKS	13
10.	390X190X190 mm SOLID BLOCKS	14
11.	400X200X200 mm SOLID BLOCKS	15
12.	SEMI HOLLOW BLOCKS	16
13.	4" HOLLOW BLOCKS	17
14.	8" HOLLOW BLOCKS	18
15.	COLOUR RANGE	20
16.	COLOUR BRICKS	22
17.	FAQ'S	24
18.	OUR ESTEEMED CLIENTS	28
19.	OUR OTHER PRODUCTS	30
20.	FACILITIES	31

INTRODUCTION



WHO WE ARE :

Most important for any Structure, be it, Industrial, Commercial, Residential, Hospitals, Schools etc. is that, it should last for the next generation which is only possible with Consistent Bricks, Blocks, Pavers of High quality and Ultra High Strength. Consistent products makes you feel safe and will last forever.

OUR ETHOS

VISION

To be recognized as a leader in manufacturing finest fly ash Bricks, Blocks and Pavers used to construct your dream home.

MISSION

To manufacture and supply high quality and innovative range of Bricks, Blocks and Pavers to give a whole new definition of strong construction.

VALUES

We believe in keeping ourselves ahead of the time and churnout something new in the field of construction. To push our trained staff who are the backbone of our successful company and bring out the best in the changing scenario of construction.

OUR PRODUCTS



FLY ASH BRICKS
 SIZE-225X90X75mm



FLY ASH BRICKS
 SIZE-225X100X75mm

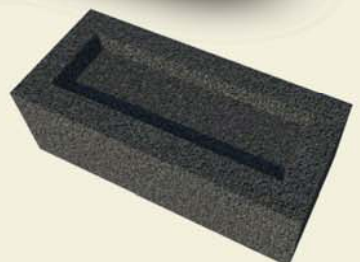

FLY ASH FROG BRICKS
 SIZE-225X100X75mm



FLY ASH FROG BRICKS
 SIZE-230X110X75mm



SOLID BLOCKS
 SIZE-390X190X90mm



SOLID BLOCKS
 SIZE-400X200X150mm

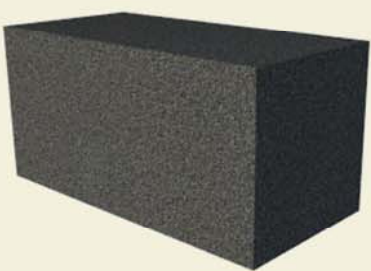

SOLID BLOCKS
 SIZE-390X190X190mm

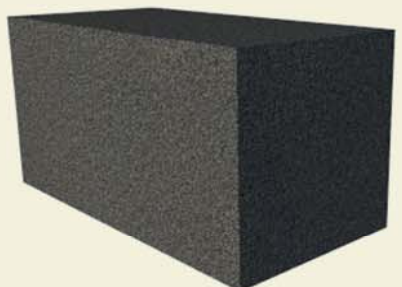

SOLID BLOCKS
 SIZE-400X200X200mm



HOLLOW BRICKS
 SIZE-230X110X112.5mm



HOLLOW BLOCKS
 SIZE-390X190X90mm

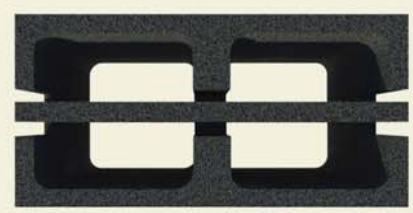

HOLLOW BLOCKS
 SIZE-390X190X190mm



THERMAL INSULATION

PRODUCTS FEATURE

CONSISTENT BRICKS AND BLOCKS

We produce a full range of Fly-Ash Bricks and Concrete Blocks in various shapes and sizes that are easy to construct with and ideal for all building projects. We also manufacture colored architectural bricks and blocks for outer elevation of houses and boundary walls. We have wide range of colored bricks and blocks that enhance and provide a beautiful contemporary look to a building's architecture.



Ultra High Strength
(Double strength & Double safety)

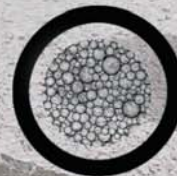

Hard & Dense Structure
(Highly durable)

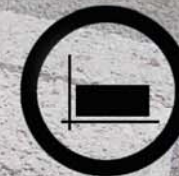

Uniform size & shape
(Precisely Engineered)



Low Water Absorption
(Damp Proof)



Efflorescence Free
(Protect Costly Paint)



Increase Carpet Area
(Cost Saving)



Rapid Installation
(Faster Completion of Projects)



Steel and Plaster
(Massive saving)



Eco Friendly
(Save earth)

STRUCTURAL BRICKS (225X90X75)

COVERAGE AREA (90mm wall):

1 sq.ft = 5.33 nos.
 1 sq.mt = 59.26 nos.
 100 sq.ft = 533 nos.

COVERAGE AREA (75mm wall) :

1 sq.ft = 4.5 nos.
 1 sq.mt = 50 nos.
 100 sq.ft = 450 nos.

IDEAL USE FOR EXTERNAL WALL

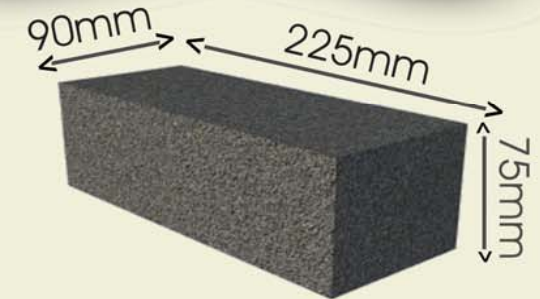

Weight = 2.8 kg

TECHNICAL SPECIFICATION

Parameters	Unit	Consistent Bricks	Requirements as per IS 12894:2002 & IS 3495 (Part I to IV)
Bulk Density	kg/m ³	1800-1850 kg/m ³	1700 - 1850 kg/m ³
Compressive Strength	N/mm ²	8 N/mm ²	Not Less than 3.5 N/mm ²
Water Absorption	%	8-12% by weight	Not exceed 20 %
Efflorescence	-	Nil	Confirming IS Standard
Breakage	%	Less than 3 %	-
DIMENSIONS (mm)			
Length	mm	225 mm	225 ± 4 mm
Width	mm	90 mm	90 ± 2 mm
Height	mm	75 mm	75 ± 2 mm

APPLICATION AREA

- Residential buildings
- Commercial buildings
- High - rise projects
- Bungalows
- Industrial projects
- Institutional projects
- Villas
- Compound walls

GIVES BEST RESULT WITH



"Thin Mortar Joints
 Only 3mm thin
 Joint required"

READY - MIX THIN LAYER JOINT MORTAR



"Only 10mm
 joint required"

READY - MIX CEMENT SAND MORTAR



STANDARD PLASTER METHOD

Better Bonding Strength

Labour Saving and Cost Saving

No Post Curing For Thin Layer Mortar

Less Shrinkage

Less Cracking

Up to **15%** saving in **steel**
 Massive **saving** in **Plaster**
 Increases in **Carpet Area**
 Up to **25%** saving in **Brick work**

Ultra-High strength => Only **90mm** External Wall thickness
 Ultra-High strength => Only **75mm** Internal Wall thickness



ELECTRICAL INSTALLATION

PLUMBING INSTALLATION

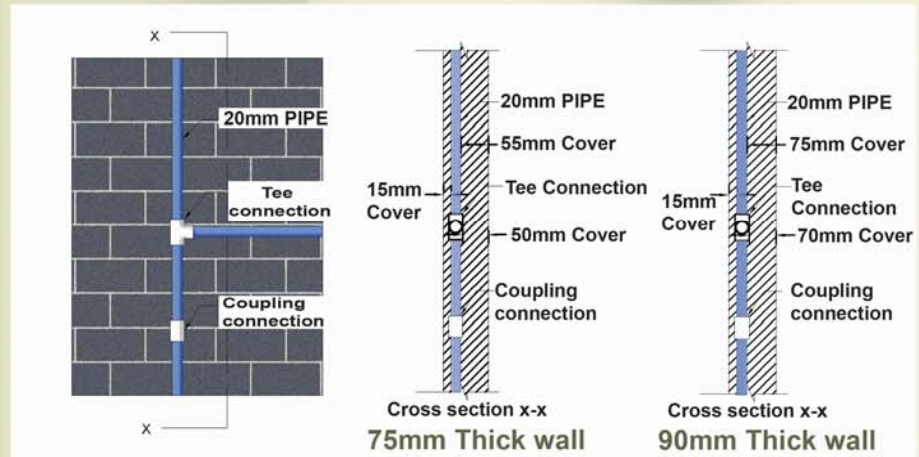
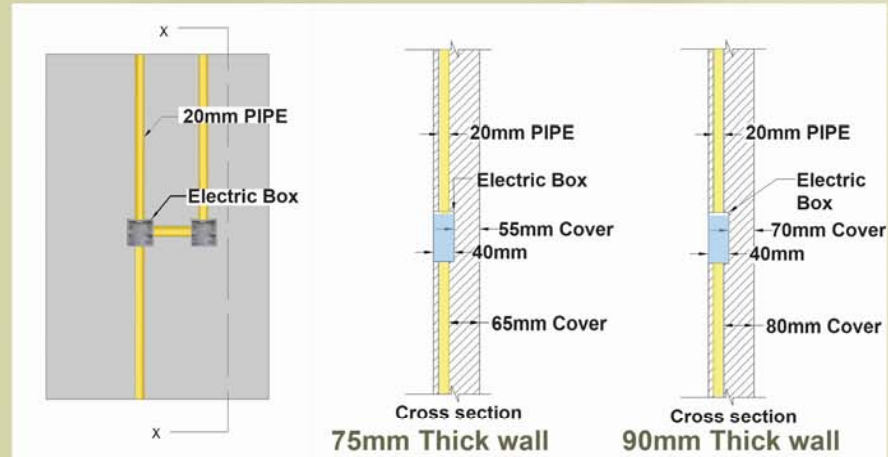

IDEAL USE FOR EXTERNAL AND INTERNAL WALL

NORMAL BRICKS (225X100X75)

COVERAGE AREA (100mm wall)
 1 sq.ft = 5.33 nos.
 1 sq.mt = 59.26 nos.
 100 sq.ft = 533 nos.

COVERAGE AREA (75mm wall) :
 1 sq.ft = 4 nos.
 1 sq.mt = 45 nos.
 100 sq.ft = 400 nos.

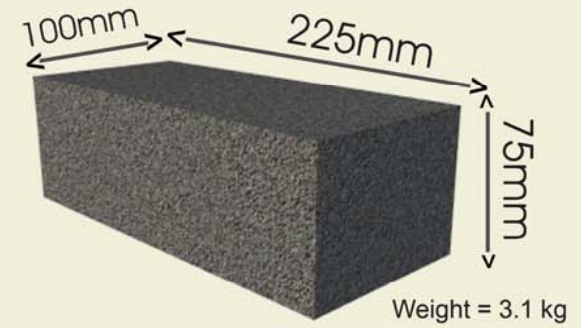

TECHNICAL SPECIFICATION

Parameters	Unit	Consistent Bricks	Requirements as per IS 12894:2002 & IS 3495 (Part I to IV)
Bulk Density	kg/m ³	1800-1850 kg/m ³	1700 - 1850 kg/m ³
Compressive Strength	N/mm ²	8 N/mm ²	Not Less than 3.5 N/mm ²
Water Absorption	%	8-12% by weight	Not exceed 20 %
Efflorescence	-	Nil	Confirming IS Standard
Breakage	%	Less than 3 %	-
DIMENSIONS (mm)			
Length	mm	225 mm	225 ± 4 mm
Width	mm	100 mm	100 ± 2 mm
Height	mm	75 mm	75 ± 2 mm

APPLICATION AREA

- Residential buildings
- Commercial buildings
- High - rise projects
- Bungalows
- Industrial projects
- Institutional projects
- Villas
- Compound walls

GIVES BEST RESULT WITH



"Thin Mortar Joints
 Only 3mm thin
 Joint required"

READY - MIX THIN LAYER JOINT MORTAR



"Only 10mm
 joint required"

READY - MIX CEMENT SAND MORTAR



STANDARD PLASTER METHOD

- Better Bonding Strength
- Labour Saving and Time Saving
- Substitutes the cement sand mortar
- Less Shrinkage
- Less Cracking

Up to **15%** saving in **Steel**
 Massive **saving** in **Plaster**
 Increases in **Carpet Area**
 Up to **25%** saving in **Brick work**

Ultra-High strength => Only **100mm** External Wall thickness
 Ultra-High strength => Only **75mm** Internal Wall thickness

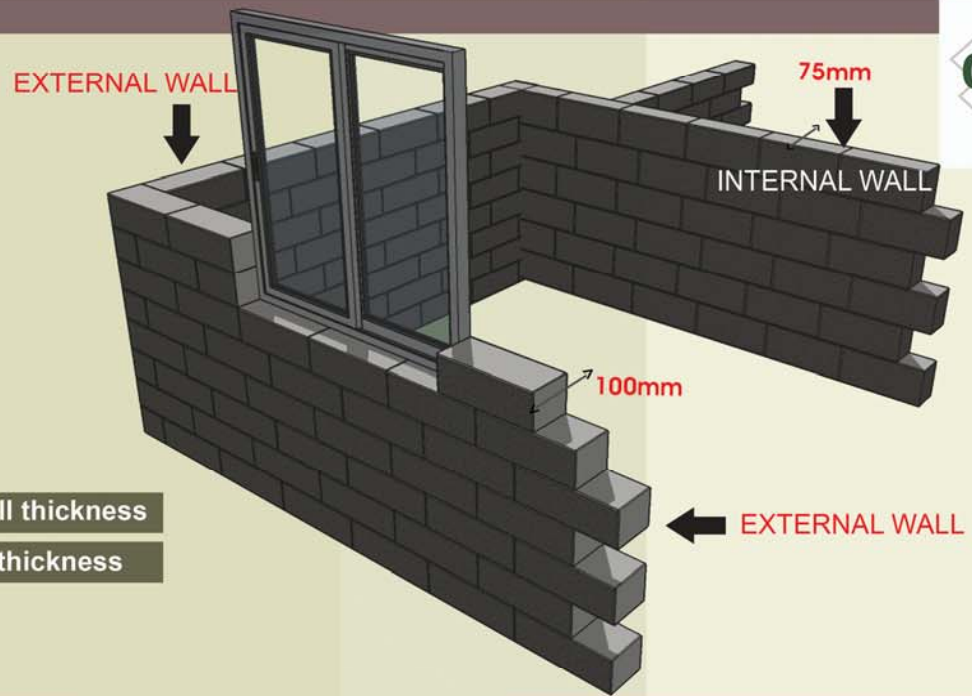

ELECTRICAL INSTALLATION

PLUMBING INSTALLATION

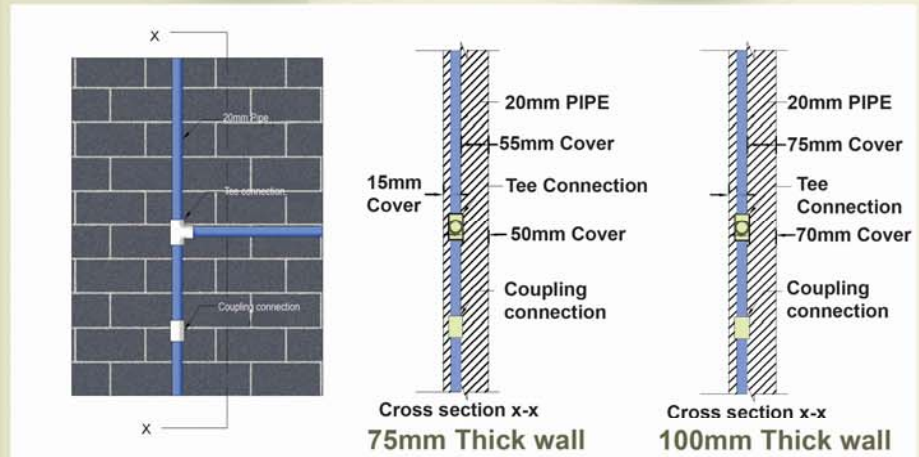
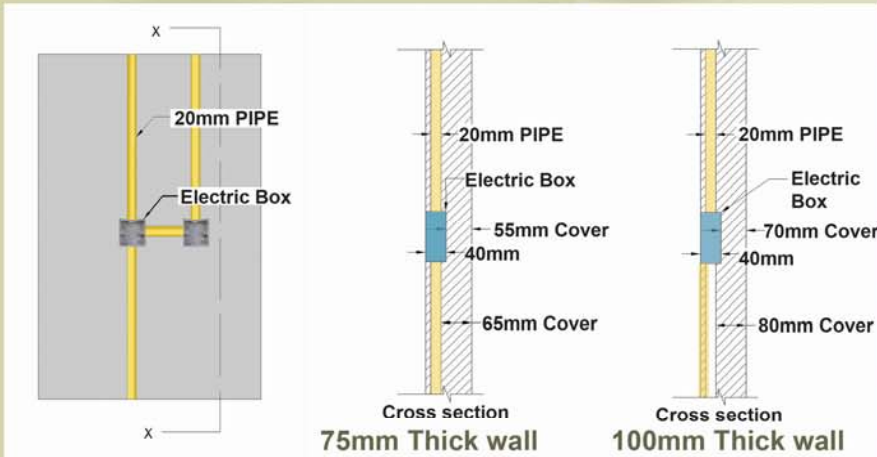

IDEAL USE FOR GENERAL CONSTRUCTION

FROG BRICK (225X100X75)

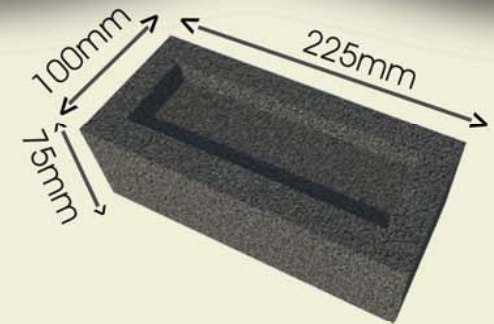

Weight = 3.2 kg

COVERAGE AREA (100mm wall)

1 sq.ft = 5.33 nos.
 1 sq.mt = 59.26 nos.
 100 sq.ft = 533 nos.

TECHNICAL SPECIFICATION

Parameters	Unit	Consistent Bricks	Requirements as per IS 12894:2002 & IS 3495 (Part I to IV)
Bulk Density	kg/m ³	1800-1850 kg/m ³	1700 - 1850 kg/m ³
Compressive Strength	N/mm ²	8 N/mm ²	Not Less than 3.5 N/mm ²
Water Absorption	%	8-12% by weight	Not exceed 20 %
Efflorescence	-	Nil	Confirming IS Standard
Breakage	%	Less than 3 %	-
DIMENSIONS (mm)			
Length	mm	225 mm	225 ± 4 mm
Width	mm	100 mm	100 ± 2 mm
Height	mm	75 mm	75 ± 2 mm

APPLICATION AREA

- Residential buildings
- Commercial buildings
- High - rise projects
- Bungalows
- Industrial projects
- Institutional projects
- Villas
- Compound walls

- Better Bonding Strength
- Labour Saving and Time Saving
- Less Shrinkage
- Substitutes the cement sand mortar
- Less Cracking

GIVES BEST RESULT WITH



READY - MIX CEMENT SAND MORTAR



STANDARD PLASTER METHOD

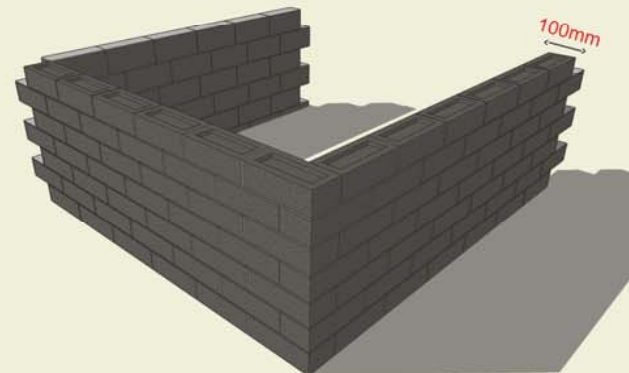

IDEAL USE FOR BUNGALOW PROJECTS

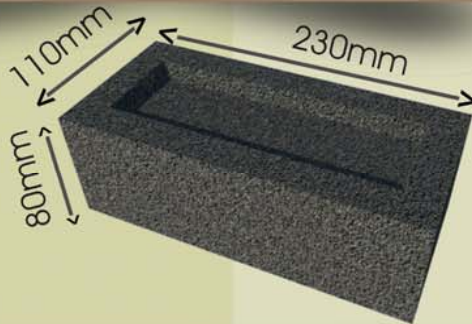

Weight = 3.5 kg

BIG FROG BRICK (230X110X80)

QUANTITY PER:

1 sq.ft = 5.21 nos.

1 sq.mt = 60 nos.

100 sq.ft. = 521 nos.

TECHNICAL SPECIFICATION

Parameters	Unit	Consistent Bricks	Requirements as per IS 12894:2002 & IS 3495 (Part I to IV)
Bulk Density	kg/m ³	1800-1850 kg/m ³	1700 - 1850 kg/m ³
Compressive Strength	N/mm ²	8 N/mm ²	Not Less than 3.5 N/mm ²
Water Absorption	%	8-12% by weight	Not exceed 20 %
Efflorescence	-	Nil	Confirming IS Standard
Breakage	%	Less than 3 %	-
DIMENSIONS (mm)			
Length	mm	230mm	230± 4 mm
Width	mm	110mm	110± 2 mm
Height	mm	80mm	80 ± 2 mm

APPLICATION AREA

- Residential buildings
- Commercial buildings
- Low - rise projects
- Bungalows
- Industrial projects
- Institutional projects
- Villas
- Compound walls

Better Bonding Strength

Labour Saving and Time Saving

Less Shrinkage

Substitutes the cement sand mortar

Less Cracking

GIVES BEST RESULT WITH



"Only 10mm joint required"

READY - MIX CEMENT SAND MORTAR



STANDARD PLASTER METHOD

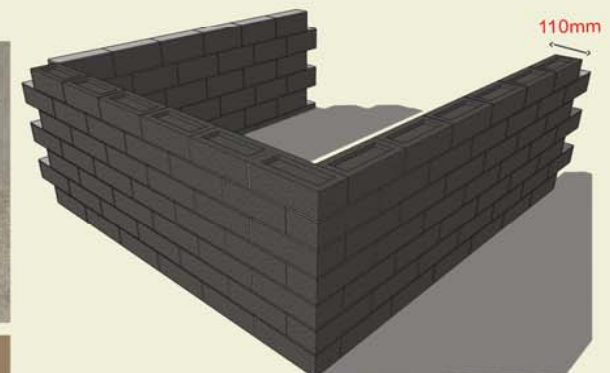

IDEAL USE FOR INTERNAL WALL

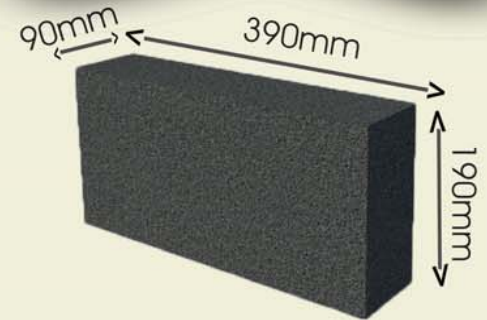

Weight = 14 kg

SOLID BLOCK (390X190X90)

coverage area :

1 sq.ft = 1.21 nos.
 1 sq.mt = 13.5. nos.
 1 cu.mt. = 150 nos.

TECHNICAL SPECIFICATION

Parameters	Unit	Solid Block	Requirements as per IS 2185: 2005
Bulk Density	kg/m ³	1950-2050 kg/m ³	Not less than 1800 kg/m ³
Compressive Strength	N/mm ²	8-9 N/mm ²	Not Less than 5 N/mm ²
Water Absorption	%	7-8 % by mass	Not exceed 10 %
Drying Shrinkage	%	0.04%	Not exceed 0.06 %
Moisture Movement	%	0.06%	Not exceed 0.09 %
Efflorescence	-	Nil	Confirming IS Standard
Breakage	%	Less than 2 %	-
DIMENSIONS (mm)			
Length	mm	390 mm	390 ± 5 mm
Width	mm	190 mm	190 ± 3 mm
Height	mm	90 mm	90 ± 3 mm

APPLICATION AREA

- Residential buildings
- Commercial buildings
- High - rise projects
- Bungalows
- Industrial projects
- Institutional projects
- Villas
- Compound walls

- Better Bonding Strength
- Labour Saving
- Material Saving
- Less Shrinkage
- Less Cracking

GIVES BEST RESULT WITH



READY - MIX CEMENT SAND MORTAR



STANDARD PLASTER METHOD

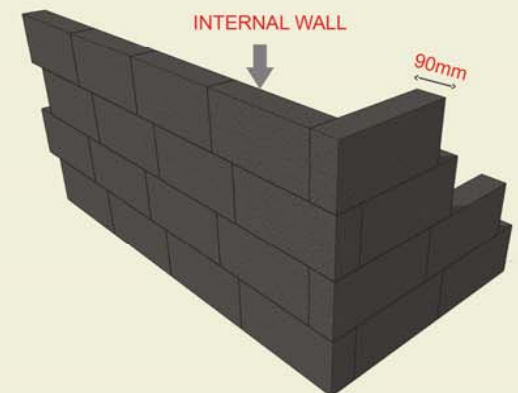

IDEAL USE FOR INDUSTRIAL STRUCTURE

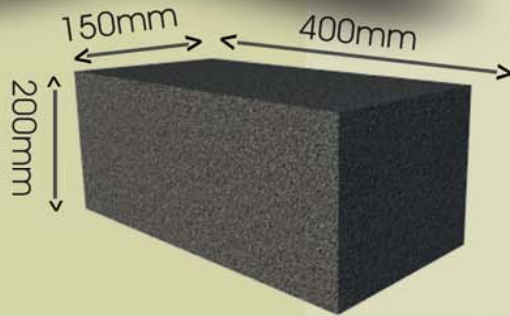

SOLID BLOCK (400X200X150)

QUANTITY PER :

1 sq.ft = 1.125 nos.
 1 sq.mt = 12.5 nos.
 1 cu.mt. = 83.33 nos.

Weight = 28 kg

TECHNICAL SPECIFICATION

Parameters	Unit	Solid Block	Requirements as per IS 2185: 2005
Bulk Density	kg/m ³	1950-2050 kg/m ³	Not less than 1800 kg/m ³
Compressive Strength	N/mm ²	8-9 N/mm ²	Not Less than 5 N/mm ²
Water Absorption	%	7-8 % by mass	Not exceed 10 %
Drying Shrinkage	%	0.04%	Not exceed 0.06 %
Moisture Movement	%	0.06%	Not exceed 0.09 %
Efflorescence	-	Nil	Confirming IS Standard
Breakage	%	Less than 2 %	-
DIMENSIONS (mm)			
Length	mm	400 mm	400 ± 5 mm
Width	mm	200 mm	200 ± 3 mm
Height	mm	150 mm	150 ± 3 mm

APPLICATION AREA

- Residential buildings
- Bungalows
- Industrial projects
- Institutional projects
- Villas
- Compound walls
- Factories
- Basement
- Boundary walls

Better Bonding Strength

Labour Saving

Material Saving

Less Shrinkage

Less Cracking

GIVES BEST RESULT WITH



READY - MIX CEMENT SAND MORTAR



STANDARD PLASTER METHOD

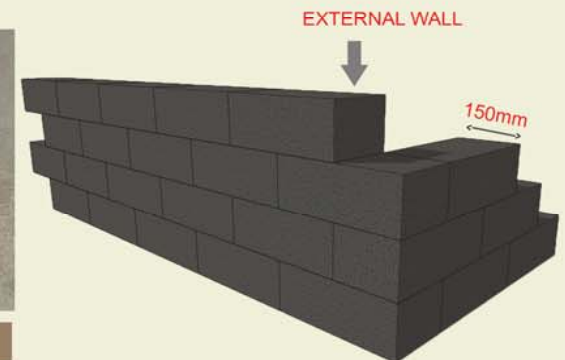

IDEAL USE FOR LOAD BEARING STRUCTURE

SOLID BLOCK (390X190X190)

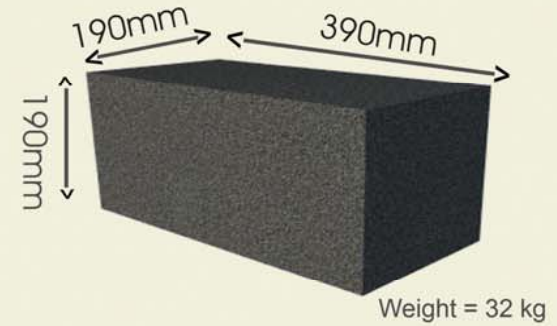

QUANTITY PER :
 1 sq.ft = 1.21 nos.
 1 sq.mt = 13.49. nos.
 1 cu.mt. = 71 nos.

TECHNICAL SPECIFICATION

Parameters	Unit	Solid Block	Requirements as per IS 2185: 2005
Bulk Density	kg/m ³	1950-2050 kg/m ³	Not less than 1800 kg/m ³
Compressive Strength	N/mm ²	8-9 N/mm ²	Not Less than 5 N/mm ²
Water Absorption	%	7-8 % by mass	Not exceed 10 %
Drying Shrinkage	%	0.04%	Not exceed 0.06 %
Moisture Movement	%	0.06%	Not exceed 0.09 %
Efflorescence	-	Nil	Confirming IS Standard
Breakage	%	Less than 2 %	-
DIMENSIONS (mm)			
Length	mm	390 mm	390 ± 5 mm
Width	mm	190 mm	190 ± 3 mm
Height	mm	190 mm	190 ± 3 mm

APPLICATION AREA

- Residential buildings
- Bungalows
- Industrial projects
- Institutional projects
- Villas
- Compound walls
- Factories
- Basement
- Boundary walls

- Better Bonding Strength
- Labour Saving
- Material Saving
- Less Shrinkage
- Less Cracking

GIVES BEST RESULT WITH



READY - MIX CEMENT SAND MORTAR



STANDARD PLASTER METHOD

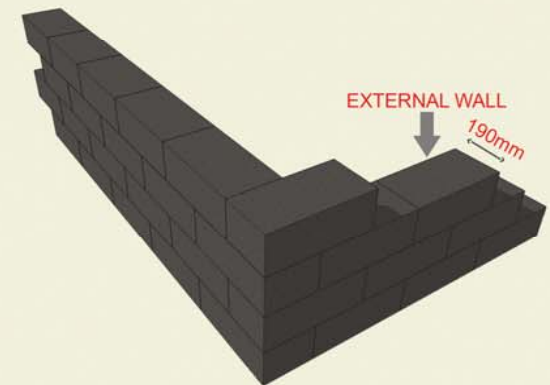

IDEAL USE FOR LOAD BEARING STRUCTURE

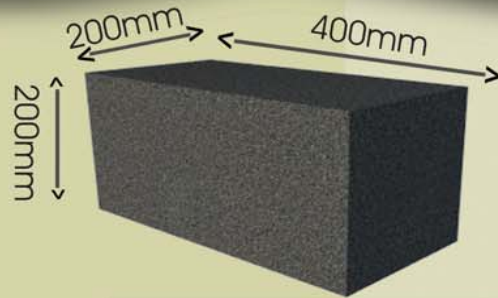

SOLID BLOCK (400X200X200)

QUANTITY PER :

1 sq.ft = 1.125 nos.
 1 sq.mt = 12.5 nos.
 1 cu.mt. = 62.5 nos.

Weight = 36 kg

TECHNICAL SPECIFICATION

Parameters	Unit	Solid Block	Requirements as per IS 2185: 2005
Bulk Density	kg/m ³	1950-2050 kg/m ³	Not less than 1800 kg/m ³
Compressive Strength	N/mm ²	8-9 N/mm ²	Not Less than 5 N/mm ²
Water Absorption	%	7-8 % by mass	Not exceed 10 %
Drying Shrinkage	%	0.04%	Not exceed 0.06 %
Moisture Movement	%	0.06%	Not exceed 0.09 %
Efflorescence	-	Nil	Confirming IS Standard
Breakage	%	Less than 2 %	-
DIMENSIONS (mm)			
Length	mm	400 mm	400 ± 5 mm
Width	mm	200 mm	200 ± 3 mm
Height	mm	200 mm	200 ± 3 mm

APPLICATION AREA

- Residential buildings
- Commercial buildings
- Low - rise projects
- Bungalows
- Industrial projects
- Institutional projects
- Villas
- Compound wall
- Factories
- Basement Level
- Boundary wall

- Better Bonding Strength
- Labour Saving
- Material Saving
- Less Shrinkage
- Less Cracking

GIVES BEST RESULT WITH



READY - MIX CEMENT SAND MORTAR



STANDARD PLASTER METHOD

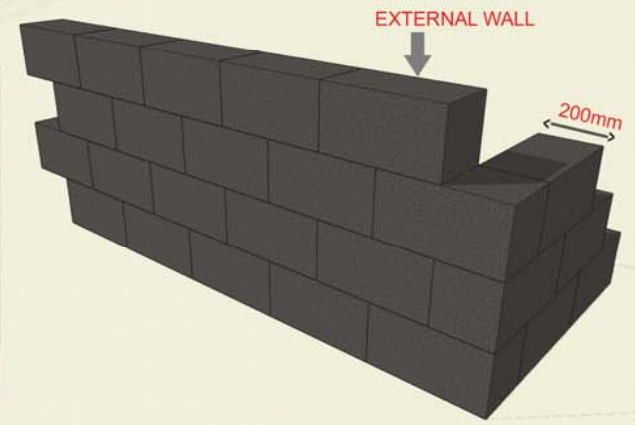

IDEAL USE FOR LIGHT WEIGHT STRUCTURE

SEMI-HOLLOW BLOCK (230X110X112.5)

QUANTITY PER :

1 sq.ft = 3.5 nos.
 1 sq.mt = 39 nos.
 1 cu.mt. = 351.5 nos.

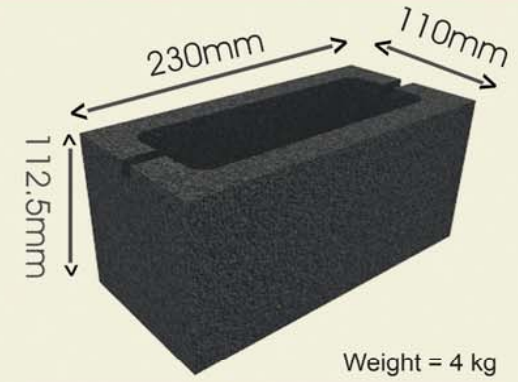

TECHNICAL SPECIFICATION

Parameters	Unit	Solid Block	Requirements as per IS 2185: 2005
Bulk Density	kg/m ³	1200-1250 kg/m ³	Not less than 1100 kg/m ³
Compressive Strength	N/mm ²	8 N/mm ²	Not Less than 4 N/mm ²
Water Absorption	%	7-8 % by mass	Not exceed 10 %
Drying Shrinkage	%	0.04%	Not exceed 0.06 %
Moisture Movement	%	0.06%	Not exceed 0.09 %
Efflorescence	-	Nil	Confirming IS Standard
Breakage	%	Less than 3 %	-
DIMENSIONS (mm)			
Length	mm	230 mm	230 ± 3 mm
Width	mm	110 mm	110 ± 2 mm
Height	mm	112.5 mm	112.5 ± 2 mm

APPLICATION AREA

- Residential buildings
- Commercial buildings
- Bungalows
- Villas
- Compound walls
- Partition walls
- Boundary walls

Better Bonding Strength

Labour Saving

Material Saving

Less Shrinkage

Less Cracking

GIVES BEST RESULT WITH



READY - MIX CEMENT SAND MORTAR



STANDARD PLASTER METHOD

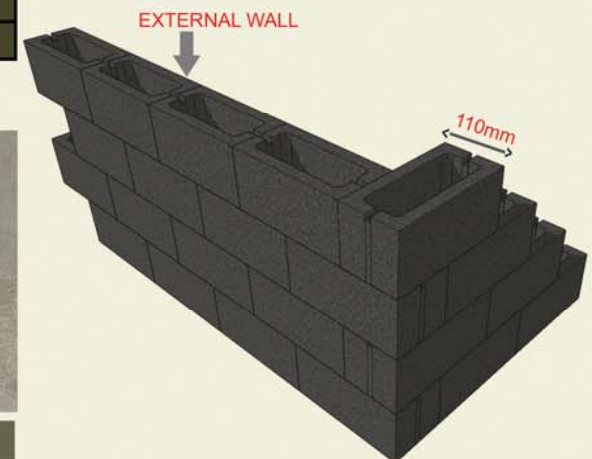

IDEAL USE FOR INTERNAL WALL

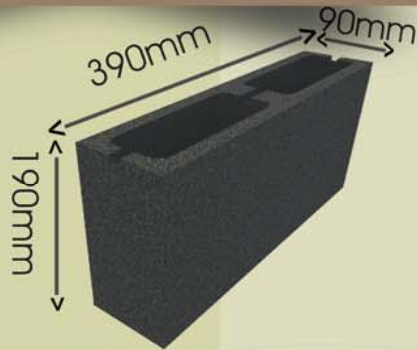

4" - HOLLOW BLOCK (390X190X90)

QUANTITY PER :

1 sq.ft = 1.21 nos.
 1 sq.mt = 13.5 nos.
 1 cu.mt. = 150 nos.

Weight = 8 kg

TECHNICAL SPECIFICATION

Parameters	Unit	Solid Block	Requirements as per IS 2185: 2005
Bulk Density	kg/m ³	1200-1250 kg/m ³	Not less than 1100 kg/m ³
Compressive Strength	N/mm ²	8 N/mm ²	Not Less than 4 N/mm ²
Water Absorption	%	7-8 % by mass	Not exceed 10 %
Drying Shrinkage	%	0.04%	Not exceed 0.06 %
Moisture Movement	%	0.06%	Not exceed 0.09 %
Efflorescence	-	Nil	Confirming IS Standard
Breakage	%	Less than 3 %	-
DIMENSIONS (mm)			
Length	mm	390 mm	390 ± 5 mm
Width	mm	190 mm	190 ± 3 mm
Height	mm	90 mm	90 ± 3 mm

APPLICATION AREA

- Residential buildings
- Commercial buildings
- Bungalows
- Villas
- Compound walls
- Partition walls
- Basement
- Boundary walls

Better Bonding Strength

Labour Saving

Material Saving

Less Shrinkage

Less Cracking

GIVES BEST RESULT WITH



READY - MIX CEMENT SAND MORTAR



STANDARD PLASTER METHOD

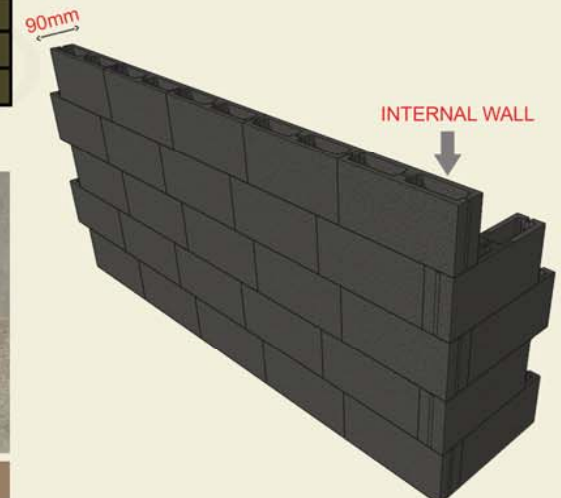

8"- HOLLOW BLOCK (390X190X190)

IDEAL USE FOR EXTERNAL WALLS

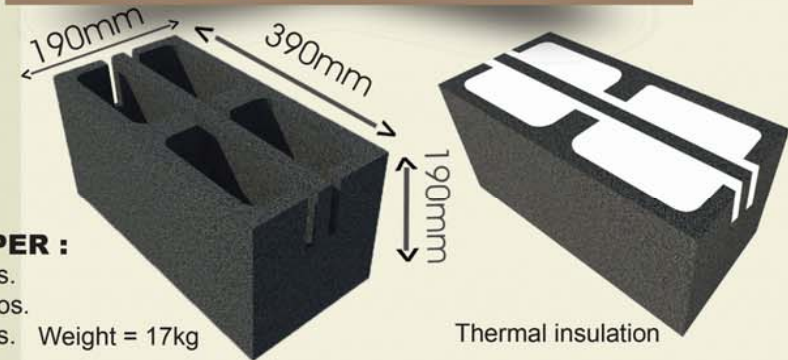

QUANTITY PER :

1 sq.ft = 1.21 nos.
 1 sq.mt = 13.5 nos.
 1 cu.mt. = 71 nos. Weight = 17kg

TECHNICAL SPECIFICATION

Parameters	Unit	Solid Block	Requirements as per IS 2185: 2005
Bulk Density	kg/m ³	1200-1250 kg/m ³	Not less than 1100 kg/m ³
Compressive Strength	N/mm ²	8 N/mm ²	Not Less than 4 N/mm ²
Water Absorption	%	7-8 % by mass	Not exceed 10 %
Drying Shrinkage	%	0.04%	Not exceed 0.06 %
Moisture Movement	%	0.06%	Not exceed 0.09 %
Efflorescence	-	Nil	Confirming IS Standard
Breakage	%	Less than 3 %	-
DIMENSIONS (mm)			
Length	mm	390 mm	390 ± 5 mm
Width	mm	190 mm	190 ± 3 mm
Height	mm	190 mm	190 ± 3 mm

APPLICATION AREA

- Residential buildings
- Bungalows
- Villas
- Compound walls
- Partition walls
- Basement
- Boundary walls
- External walls
- Cavity walls
- Cold storages
- Industrial walls

- Better Bonding Strength**
- Labour Saving**
- Material Saving**
- Less Shrinkage**
- Less Cracking**
- Upto 50% saving in Air Condition electricity cost**

GIVES BEST RESULT WITH



READY - MIX CEMENT SAND MORTAR



STANDARD PLASTER METHOD

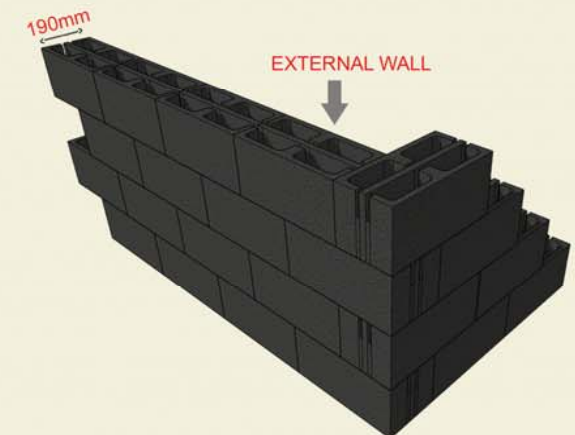

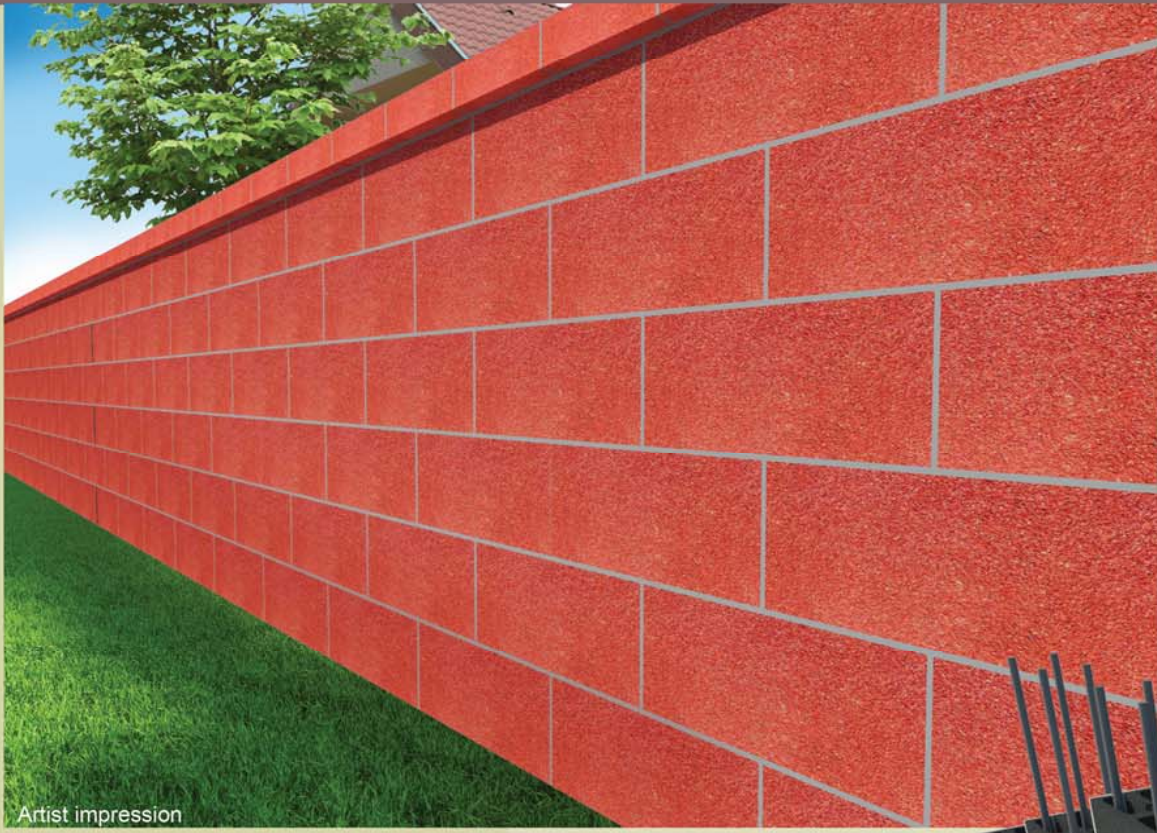

Artist impression



Actual Photo

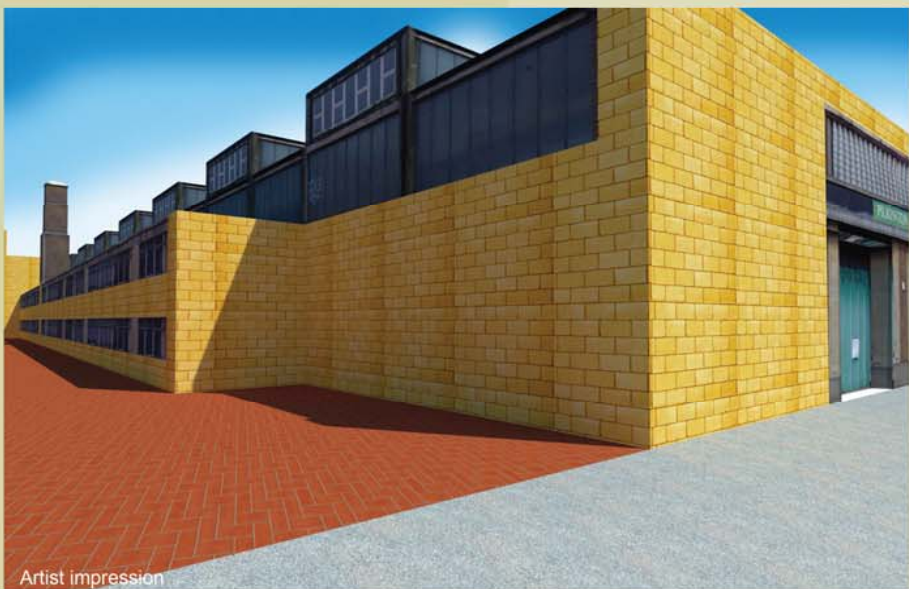

Artist impression

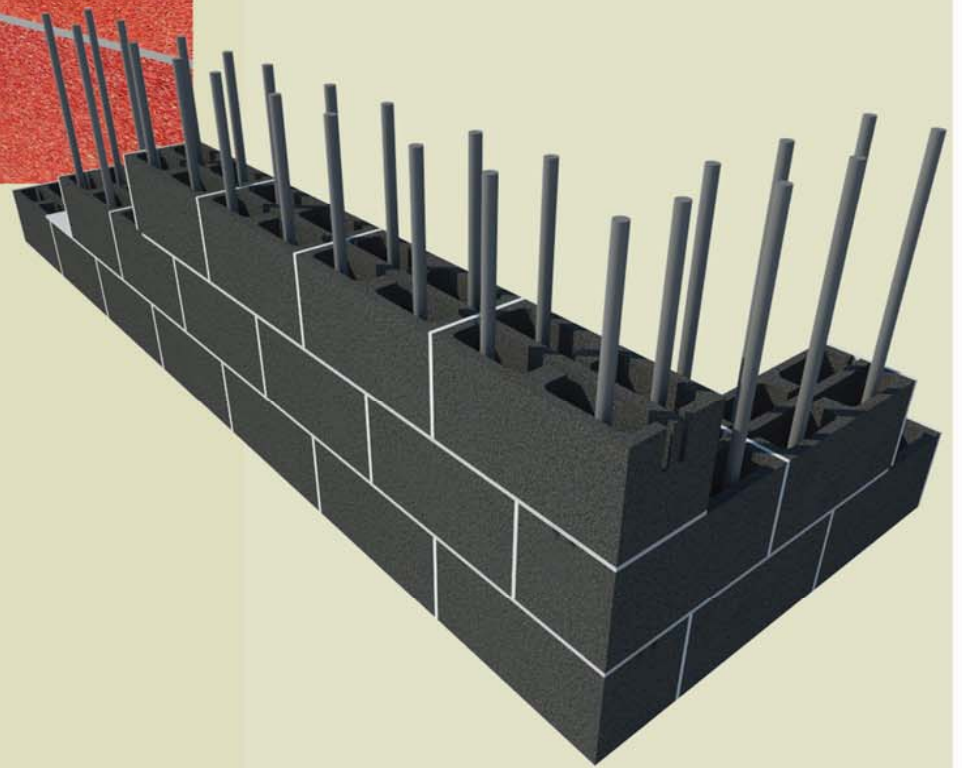

COLOUR RANGE

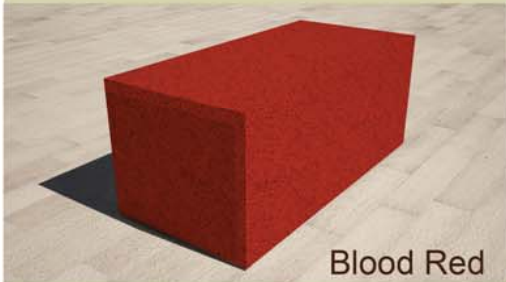

Blood Red



Combo Orange

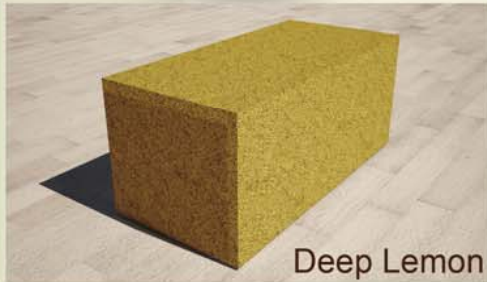

Deep Lemon

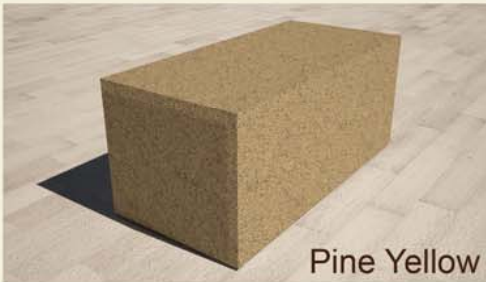

Pine Yellow



Amber

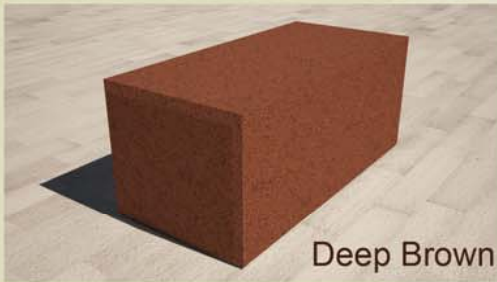

Deep Brown



Silver Grey



Olive Black

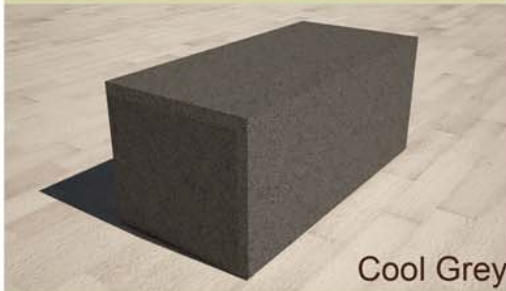

Cool Grey

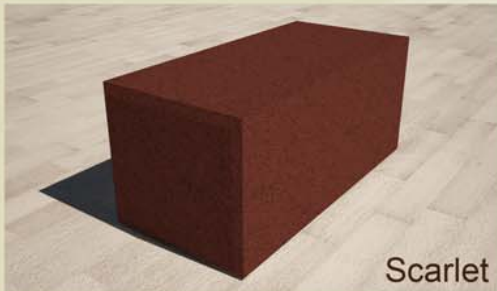

Scarlet



Tomato Red

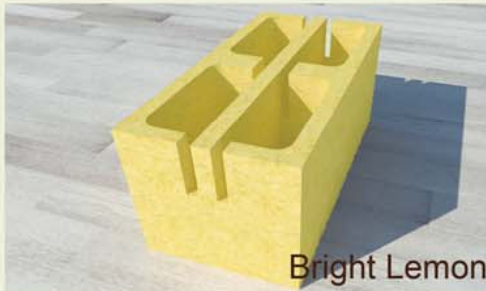

Bright Lemon

We use only high quality pigments coloured concrete offers added value for anyone who works with it because it added permanent beauty to standard construction material. Our wide range of colour bricks product may enhance the architectural effects and increases the property value.



Camel Brown

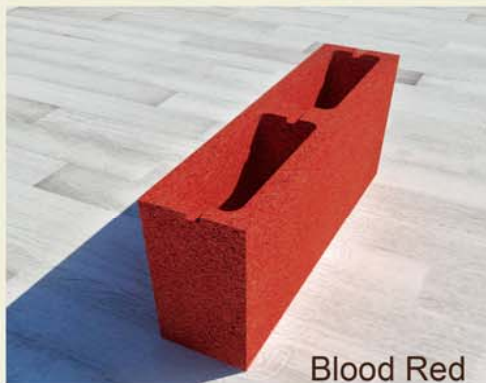

Blood Red

Note: Above colour are digital photos. Actual product colours may be little different.



Artist impression

IDEAL USE FOR EXPOSED BRICK WORK

COLOUR BRICKS (225X100X75)

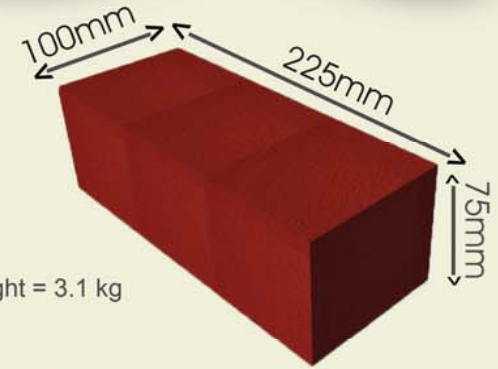

COVERAGE AREA

(100mm wall)

1 sq.ft = 5.33 nos.

1 sq.mt = 59.26 nos.

100 sq.ft = 533 nos.

TECHNICAL SPECIFICATION

Parameters	Unit	Consistent Bricks	Requirements as per IS 12894:2002 & IS 3495 (Part I to IV)
Bulk Density	kg/m ³	1800-1850 kg/m ³	1700 - 1850 kg/m ³
Compressive Strength	N/mm ²	8 N/mm ²	Not Less than 3.5 N/mm ²
Water Absorption	%	8-12% by weight	Not exceed 20 %
Efflorescence	-	Nil	Confirming IS Standard
Breakage	%	Less than 3 %	-
DIMENSIONS (mm)			
Length	mm	225 mm	225 ± 4 mm
Width	mm	100 mm	100 ± 2 mm
Height	mm	75 mm	75 ± 2 mm

APPLICATION AREA

- Residential buildings
- Commercial buildings
- High - rise projects
- Bungalows
- Industrial projects
- Institutional projects
- Villas
- Compound walls

GIVES BEST RESULT WITH

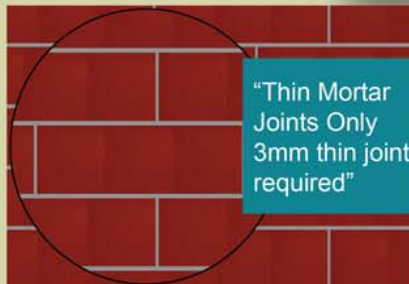

READY - MIX THIN LAYER JOINT MORTAR



READY - MIX CEMENT SAND MORTAR

Better Bonding Strength

Labour Saving and Time Saving

Less Shrinkage

Less Cracking

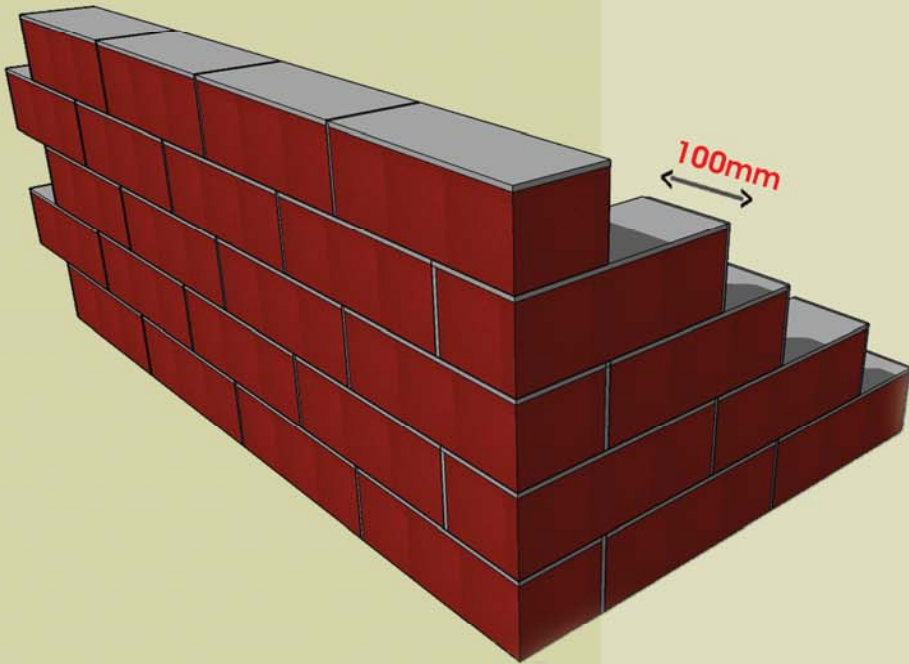

FAQ'S

1. What is Fly Ash Bricks ?

Ans : Fly ash bricks are hi-tech well-improved ultra-high strength bricks used for construction of load bearing and non-load bearing masonry structure. They are used as a replacement of normal clay bricks and AAC blocks. Fly ash bricks are more competitive in comparison to the conventional clay bricks and provides enormous indirect benefits. The utilization of fly ash bricks results in conservation of natural resources as well as protection of environment.

2. Are fly Ash bricks and blocks safe ?

Ans : In most developed countries Fly Ash Brick has been used for more than 75 years. It confirms to the highest Green Building Norms. It has the highest strength in the industry, Highest longevity and confirms to very high fire safety norms. It is made from non-toxic ingredients using methods that are not only within the industry norms but also within the ecological norms. Expert testing has proven that it is non-hazardous. It is safe to use and it is safe to produce.

3. How do I ascertain the quality of Fly Ash Bricks ?

Ans : Fly Ash bricks are manufactured in our automatic German Plant resulting in consistent quality always. To ensure consistent quality, incoming raw materials are regularly tested. Compressive strength of bricks and blocks are regularly tested in our in-house laboratory.

4. What should be used to join the blocks ?

Ans : For better bonding results use Ready-mix thin layer joint mortar. e.g. UltraTech FixoBlock or Normal Cement-Sand (1:4) Mix Mortar.

5. Will Cracks develop on the wall after plaster ?

Ans : Being a high strength product cracks in the bricks are Negligible. However, workmanship is very important to reduce the cracks issue. Sometimes shrinkage cracks may develop due to incorrect mix proportion of mortar.

FAQ'S



6. **Will there be efflorescence on the wall?**
Ans : No, there is no chance of efflorescence due to our products which results in protection of costly paint.
7. **Are the bricks and blocks load bearing ?**
Ans : Yes, it is load bearing due to ultra-high strength of our products. It may result in major saving of steel and concrete.
8. **Does the plaster stick to the block ?**
Ans : Yes, due to the rough surface finish, our products bond very well with plaster.
9. **How much should be the thickness of the plaster?**
Ans : 5-7 mm for bricks and blocks, resulting in the saving of more than 50% in plaster.
10. **How Fly Ash Bricks and Block wall masonry is cost effective in comparison to clay brick wall masonry ?**
Ans : Fly Ash Bricks, Blocks are Accurate in size Compared to traditional clay bricks which results in major saving in thickness of plaster. Fly Ash bricks and blocks requires only 5 to 7 mm plaster as compared to 15 - 20 mm wall plaster in clay bricks. This leads to substantial savings in cement-sand due to less quantity of plaster. Since Fly Ash bricks and blocks are factory manufactured, they tend to have a better finishing and are manufactured very precisely to the specifications.
11. **How to conceal plumbing and wiring installed in Fly Ash bricks and blocks wall ?**
Ans : The process is very easy. After the walls are built, the electrician draws out where the wires will go. A manual or electric router is then used to carve out the channels. After the electrician is done with the installation of the wires, regular plaster can be used to fill it up and a smooth finish can be given to it.
12. **Why is Fly Ash Bricks and Block considered as a Green Building product?**
Ans : Eco-Friendly: About 70% of the Raw Materials used to manufacture fly Ash products is aggregate, dust and fly ash which are waste products. This confirms to the highest green building rated certification across the world.

13. What is the life expectancy of Fly Ash bricks and blocks work ?

Ans : Traditional bricks are normally assumed to have a service life of 50 years. Fly Ash bricks and blocks are normally assumed to have service life till the entire life of the building.

14. Are the Fly - Ash bricks and blocks viable for high-rise projects ?

Ans : Yes, our fly-ash bricks and blocks are preferable for high-rise building projects. Due to ultra-high strength of bricks and blocks the external wall with 100mm and internal wall with 75mm are enough. It results in about 25% saving in materials and also reduces the overall wall load on the structure. Also, 75mm wall results in increase of carpet area.

15. Which products are more preferable for ground or basement level ?

Ans : Our Ultra-High Strength solid blocks are more preferable in basement level of any building. It may resist the direct horizontal thrust from the ground subsoil. Also, for earth retaining structure we can use ultra-high strength solid blocks and it may result in massive saving in steel and concrete.

16. What is the aim and vision to use Fly-Ash bricks and blocks ?

Ans : As the philosophy in India we make houses and buliding for one next generation which is only possible with ultra-high strength products. Light weight products may not use for load bearing structure. We can strongly feel safe and consistent due to ultra-high strength products.

17. What are the benefits to use this product compared to AAC blocks ?

Ans : As compared to AAC blocks, our products are ultra-high strength and it can be used for any type of load bearing and non-load bearing structure. AAC blocks can't be used in a load bearing structure due to its low compressive strength. Also, AAC blocks require higher wall thickness as compared to fly-ash bricks and blocks which results in loss of carpet area. Cracks may appear in AAC block within short duration.

FAQ'S



18. Can we use Fly - Ash bricks and blocks in a compound wall ?

Ans : Yes, it is a highly preferable product for compound wall. Infact, if we use concrete solid blocks in a compound wall then RCC columns may not be required, which results in saving of concrete and steel cost.

19. Is Fly Ash bricks and blocks government approved products ?

Ans : Nowadays, it is signature to the vision of the Government of India to restrict the excavation of top soil from earth in order to make clay bricks and instead indulge in greater utilization of Fly Ash, generated by coal/lignite based thermal power stations.

OUR ESTEEMED CLIENTS/ PROJECTS



OUR ESTEEMED CLIENTS/ PROJECTS



MARUTI DEVELOPERS

B.R STEEL

GANESH CONSTRUCTION

SUNDARAM BUILDCOM PVT. LTD.

R.J. CONSTRUCTION

and many more.....

OUR OTHER PRODUCTS

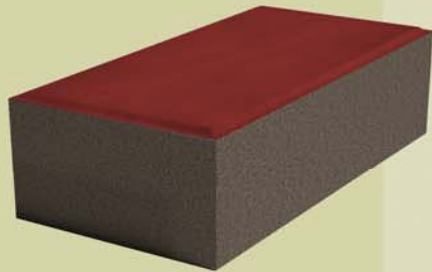

RECTANGULAR PAVER
 200X100X60 mm



RECTANGULAR PAVER
 200X100X80 mm



RECTANGULAR PAVER
 200X100X100 mm



UNI PAVER
 225X112.5X80 mm



BIG RECTANGULAR PAVER
 300x200x60 mm



BRADSTONE PAVER
 275x100x60 mm



BIG SLATE PAVER
 550x275x60 mm



BIG SQUARE PAVER
 550x550x60 mm

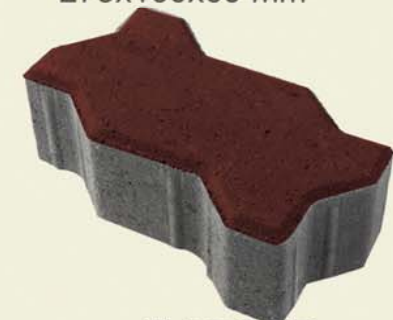

UNI PAVER
 225x112.5x60 mm

FACILITIES

The state - of - the -art plant - 'RH 500' Imported from the HESS GROUP, Germany, is the most modern and technologically advanced Block manufacturing plant in the country. The plant is fully automatic and computerized. It has unique systems to produce various products of high strength and fine finishes. We use planetary mixture from SICOMA, Italy to enable effective and consistent mix of all our raw materials. We use stream - curing system for maintaining high strength in all our products.



We use concrete products machinery from the world's renowned German Manufacturing Company HESS Group.



Head Office:

9A Esplanade East,
Near Esplanade Post office,
2nd Floor,
Kolkata- 700069
Ph : +91 9978601839
E-mail: info@kankariaholdings.in
Web-site : www.kankariaholdings.in

Marketing Office:

A 701, Privilon, Ambi BRTS road, Iscon crossroads,
Behind Iscon Temple,
Ahmedabad, Gujarat 380059
Ph : +91 9978601884
+91 9978601839
+91 7990775090
E-mail : info@kankariaholdings.in

Factory:

Survey No. 658/2 Village Bagodara,
Near Toll Tax,
Limdi Highway
Bagodra-382230,
Taluka-Bavla,
Dist. Ahmedabad- 382230

Note: Above specifications are applicable for standard products. Other specifications are also available as per customer requirement.
Actual weights and dimensions may vary.

This brochure is not a legal offering. The information, offerings and specifications are indicative and are subject to change without any prior notice.