



Ultra High Strength  
**Consistent**  
Precast Concrete Technology & Innovation  
KANKARIA PRECAST PVT. LTD.

# INDEX

## Sl. No.

● INTRODUCTION	.....	03
● OUR PRODUCTS	.....	04
● PRODUCT FEATURES	.....	05
● U - DRAIN	.....	06 - 09
● BOX CULVERT	.....	10 - 13
● CRASH BARRIER	.....	14 - 15
● TRAFFIC BARRIER	.....	16 - 17
● RE WALL PANEL	.....	18 - 19
● BEAM SECTION	.....	20 - 21
● COMPOUND WALL	.....	22 - 23
● OUR OTHER PRODUCTS	.....	24 - 27

# INTRODUCTION

## WHO WE ARE :

Consistent group manufacturer of high quality concrete bricks and blocks using high tech machineries has now forayed into manufacturing of precast products with innovative technologies having minimal impact on environment and ease and faster constructions. The products will be used in structures be it industrial, commercial, residential, Highway projects etc. which will last forever.

## OUR ETHOS

### VISION

To be recognized as a leader in manufacturing customised precast concrete products used to construct your dream project.

### MISSION

To manufacture and supply high quality and innovative customised precast concrete products to give a whole new definition to strong construction.

### VALUES

We believe in keeping ourselves ahead of time and churn out something new in the field of construction. To push our trained staff who are backbone of our successfull company and bring out the best in the changing scenario of construction industry.

# OUR PRODUCTS

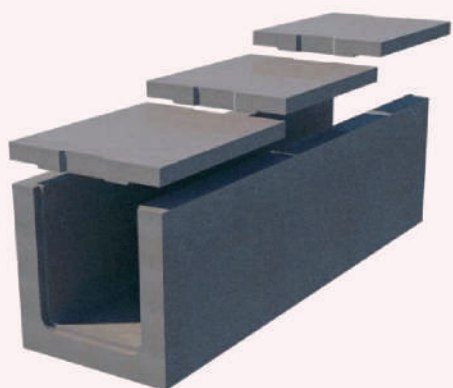

**U - DRAIN**

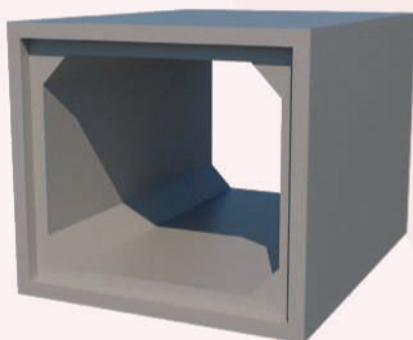

**BOX CULVERT**

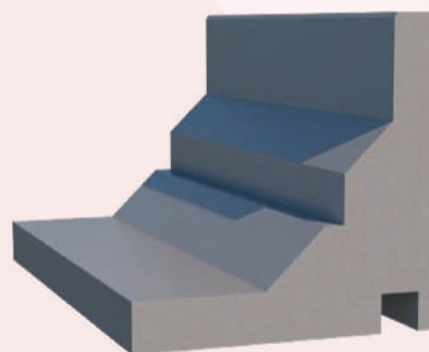

**CRASH BARRIER**



**TRAFFIC BARRIER**

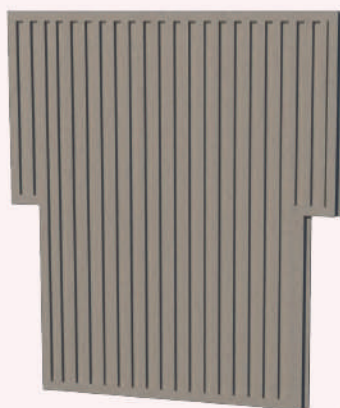

**RE WALL PANEL**

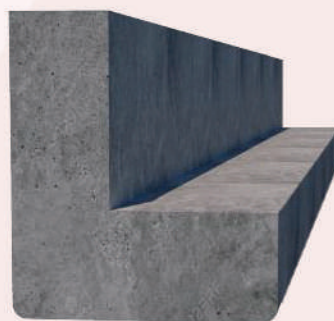

**BEAM SECTION**



**COMPOUND WALL**

# PRODUCT FEATURES



## **3X FASTER :**

Precast Concrete construction saves time, the risk of project delay is also less. The precast concrete casting can be carried on simultaneously with other works on site such as earthwork, survey, etc. and thus saves time.



## **ECONOMICAL :**

The simplified construction process reduces the time, increases the productivity, quality and safety and thus the cost is reduced.



## **QUALITY ASSURANCE :**

The key factors which regulate the quality of construction such as curing, temperature, mix design, formwork, etc. can be monitored for Precast Concrete. So, improved quality construction can be performed.



## **SAFE CONSTRUCTION PLATFORM :**

No raw materials have to be stocked in site for Precast Concrete construction. It reduces the requirement of traditional formworks and props, wastage, workers, etc. and thus provides a safe working platform.



## **DURABILITY :**

Precast Concrete structure has a longer service time period and minimal maintenance. The high-density Precast Concrete is more durable to acid attack, corrosion, impact, reduces surface voids.



## **ULTRA HIGH STRENGTH :**

Consistent concrete is a new class of concrete that has been developed in recent decades for its exceptional properties of strength and durability. This high performance concrete can be utilized in structural rehabilitation and accelerated bridge construction in addition to several other applications.

# U - DRAIN

Consistent U-Drain allow for fast construction of open flow channels using high quality factory cast units with a minimum of wet concrete works. Consistent U-Drain also come with or without Dry Weather Flow (DWF) channels and different U-Drain sizes with ease of handling and installation of Precast U-Drain, construction progress will be less affected by adverse weather and thus reduce construction period and cost.

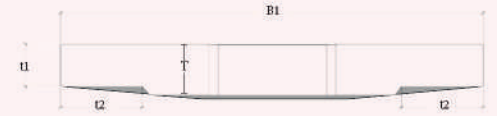
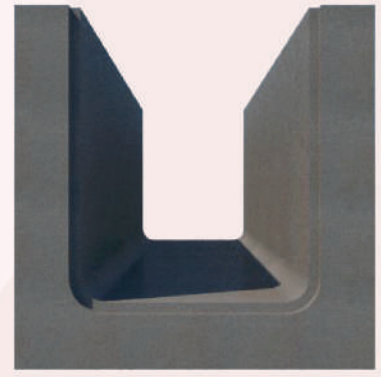
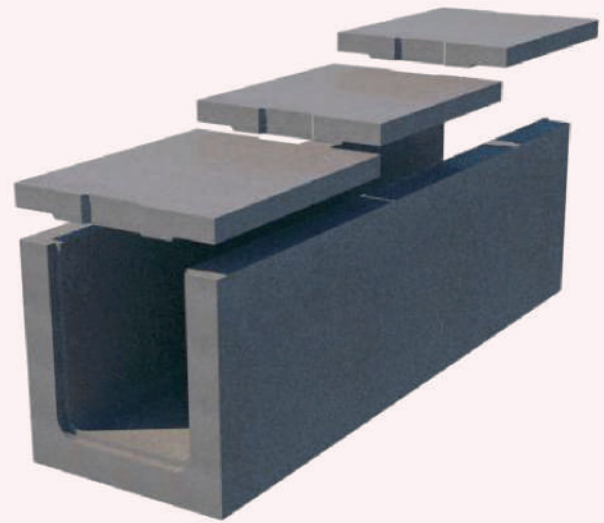

SIDE VIEW(LID)

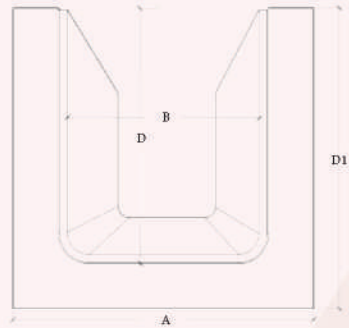

FRONT VIEW(U - DRAIN)

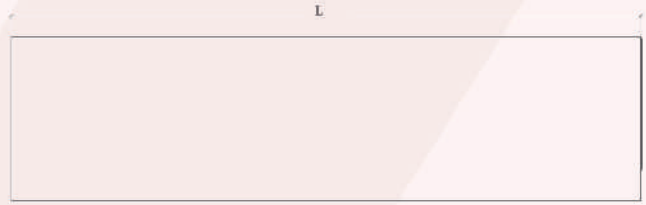

SIDE VIEW(U - DRAIN)

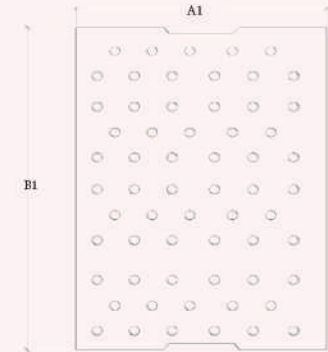

TOP VIEW(LID)



# ADVANTAGES

Easy to install

Easy to handle

Faster construction of waterways

High quality factory cast

Minimum wet concrete work



Product Size	Dimensions of U-Drain (mm)			
	B x D	L	A	D1
U 300 x 350mm		2000	500	450
U 300 x 450mm		2000	500	550
U 400 x 350mm		2000	600	450
U 450 x 450mm		2000	650	550
U 600 x 600mm		2000	800	700
U 750 x 750mm		2000	950	850
U 900 x 900mm		2000	1100	1000

Cover Size	Dimensions of Cover (mm)			
	B1 x A1	T	t1	t2
650 x 400mm		100	80	100
800 x 500mm		100	80	100
950 x 500mm		100	80	100
1100 x 1000mm		100	80	100





# HANDLING, STACKING, LAYING, JOINTING & BACKFILLING



## **Handling :**

A spreader beam to be used with steel pins and lifting cables to avoid cracking at junction of side wall and base slab.



## **Stacking :**

U-drains are to be stacked on level and stable ground to avoid cracking of base slab.



## **Laying :**

U-drains should be laid on prepared bedding to ensure uniform support under the full width and length of the U-drains.



## **Jointing & Backfilling :**

Butt joints. Gaps normally to be filled up with cement-sand mortar.

# BOX CULVERT

Precast concrete box and 3-sided culverts are incredibly versatile. It can be manufactured in wide range of sizes and configurations and can be used to convey storm water or wastewater, create short span-bridges and access ways, or for rainwater retention or detention, to name only a few applications. In addition, precast concrete 3-sided culverts allow for natural streambeds to remain intact.

Rely on precast concrete culverts for a high degree of quality and uniformity, design flexibility, superior strength and durability, reduced weather dependency during installation, and reduced impact to the job site.

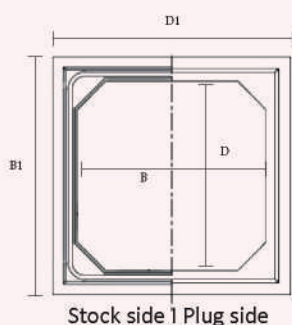
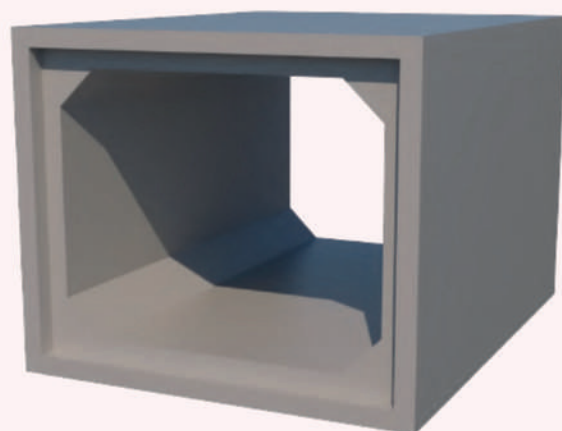

FORNT VIEW



SIDE VIEW

Product Size	Dimensions of BOX (mm)			
	B x D	L	B1	D1
BOX 300 x 300mm		1000	650	650
BOX 450 x 450mm		1000	650	650
BOX 600 x 600mm		1000	800	800
BOX 750 x 750mm		1000	950	950
BOX 900 x 900mm		1000	1100	1100

# APPLICATION AREA

Stream Culverts

Material Handling

Storage

Watertight tanks & more

Underpasses

Tunnels

Subways

Bridges



# ADVANTAGES

## Strength

We design culverts to meet or exceed required load capacity. Precast concrete can be manufactured to safely support pedestrians, livestock, automobiles, rail transportation and more.

## Uniformity

Precast concrete allows for strict control during manufacturing. The quality of poured-in-place concrete can suffer with variations in weather. Problems with temperature, curing and craftsmanship are more common when workers must contend with the wet, cool temperatures.

## Easy to Install

Precast concrete culverts can be manufactured well in advance. When it's time to install, the culvert requires a crane and a small work crew. Backfill around the structure as soon as it's installed. Once in place, other construction can begin. This ease of installation reduces budget-busting delays.

## Economical and Eco - Friendly

Installation of precast box culverts require fewer workers and hours which can ultimately save money. Our products are safe for the environment. We use recycled materials when possible and efficient processes that conserve water. Concrete is a natural material. As a company, we strive to improve our methods to ensure minimal environmental impact.





# CRASH BARRIER

Crash barriers are designed to withstand the impact of vehicles of certain weights at certain angle while travelling at the specified speed. They are expected to guide the vehicle back on the road while keeping the level of damage to vehicle as well as to the barriers within acceptable limits.

Ideally a crash barrier should present a continuous smooth face to an impacting vehicle, so that the vehicle is redirected, without overturning, to a course that is nearly parallel to the barrier face and with a lateral deceleration, which is tolerable to the motorist. To achieve these aims the vehicle must be redirected without rotation about both its horizontal or vertical axis (that is, without 'spinning out' or overturning), and the rate of lateral deceleration must be such as to cause the minimum risk of injury to the passengers.

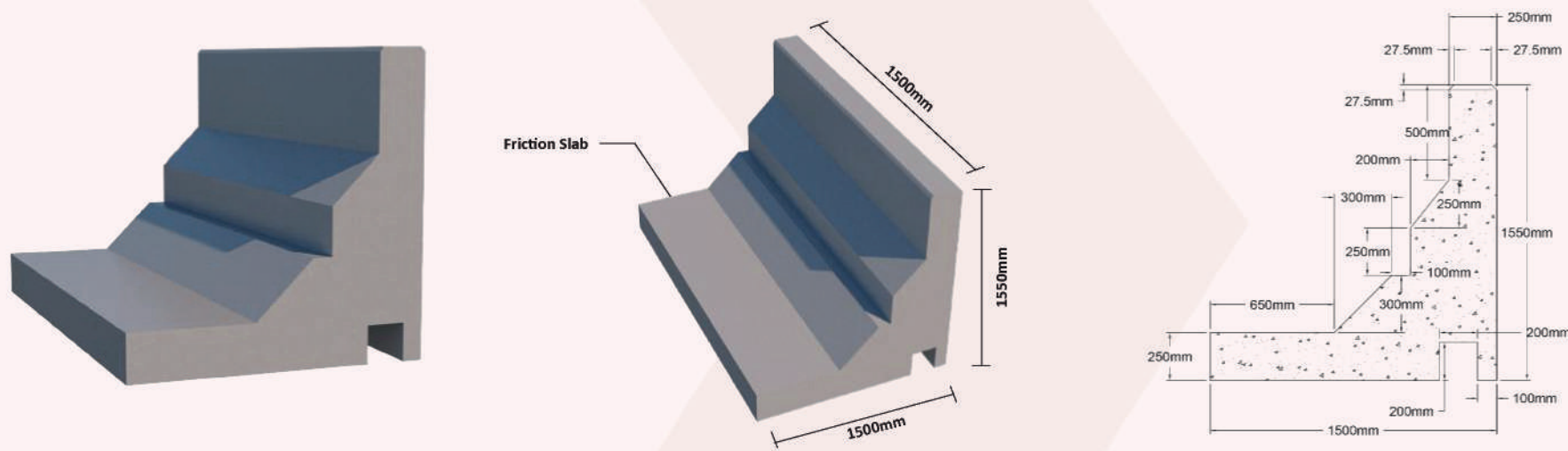

# ADVANTAGES

- Produced in a quality - controlled environment
- Economical
- Faster and safer than slip - forming
- Slip resistance

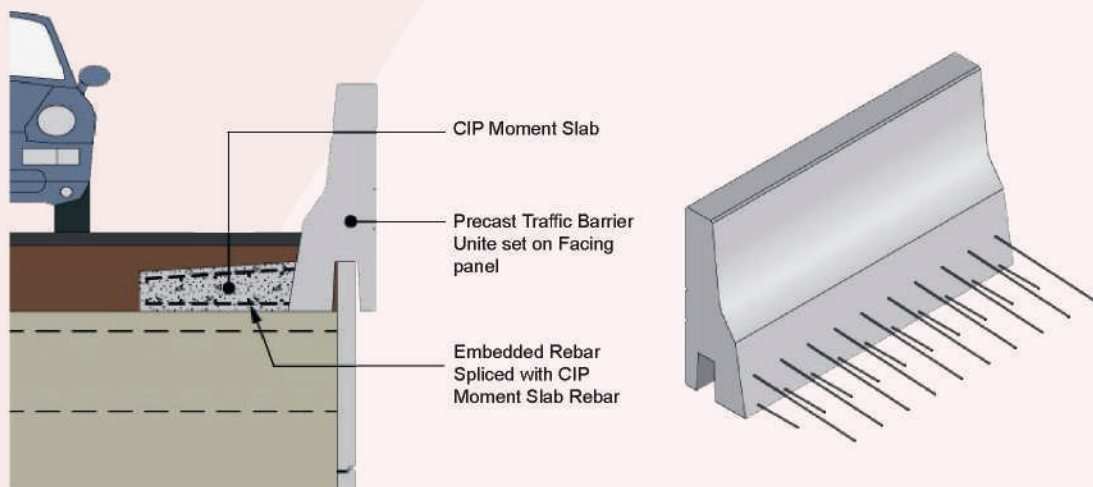

# PURPOSE OF CRASH BARRIER

- Reduces the risk of an out-of-control vehicle crossing the median and colliding with opposing traffic or roadway workers.
- Reduces the risk of a vehicle deflecting back into the traffic stream after colliding with the barrier.
- Decelerate the errant vehicle within tolerable limits.
- Directing traffic in a prescribed manner.
- Protection against unwanted vehicular traffic around buildings, utility facilities, historic landmarks and airports, etc.
- Being maintenance-free and having a life of 25 to 50 years.

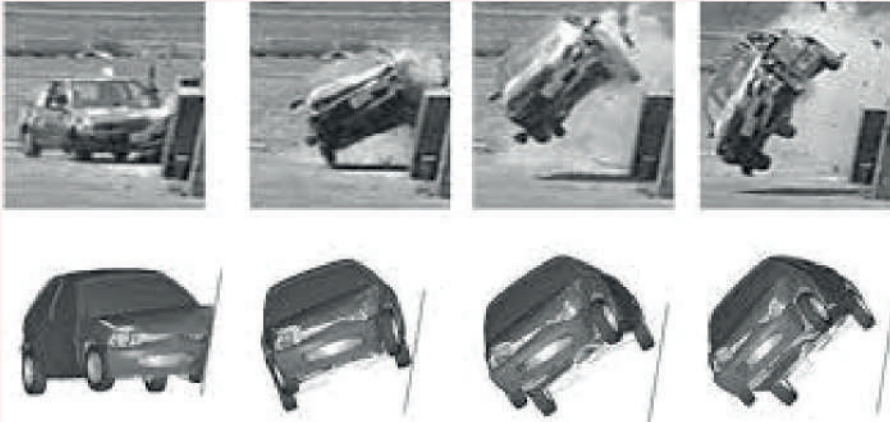

# CRASH TESTING LEVEL

There are various levels of impact performance evaluation of various safety features based upon principal performance factors:

- Structural adequacy
- Occupant risk
- Post-impact behaviour of vehicle



# TRAFFIC BARRIER

Traffic barriers reduce the risk of head on collisions from out-of-control vehicles crossing over the median. The weight of barriers and the interlocking design provide sufficient inertia to redirect an impacting vehicle without requiring attachment to the highway when a minimum run of 12-foot length barrier is used. Concrete barrier walls also decelerate errant vehicles within tolerable limits.

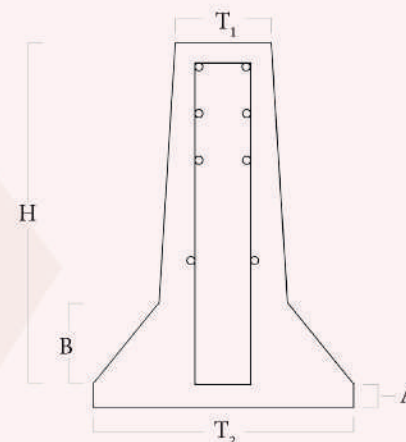
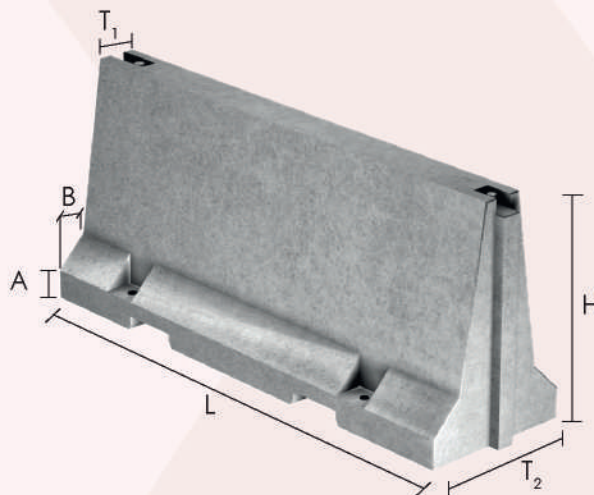



# APPLICATION AREA

- Concrete construction barriers protect construction workers by creating a high level of containment, by restraining stray vehicles from entering a work zone.
- Concrete highway barriers allow construction sites to operate safely in close proximity to busy roadways.
- Precast concrete barriers are useful for redirecting vehicles into new traffic patterns during different phases of construction.
- Precast Barrier can be used on bridges in a bolt-down installation or pinned to the pavement for roadway widening when a pavement cut is used on the edge of the roadway.



# RE WALL PANEL

RE Panel walls are a composite system of a face panel - generally concrete and a steel reinforcement element - either in the form of a steel strip or welded mesh that is positively connected one to the other such that a stable unified gravity soil mass may be formed. The facing panel is generally a precast concrete unit that provides local soil stability and a "face" for compaction of the retained soil.

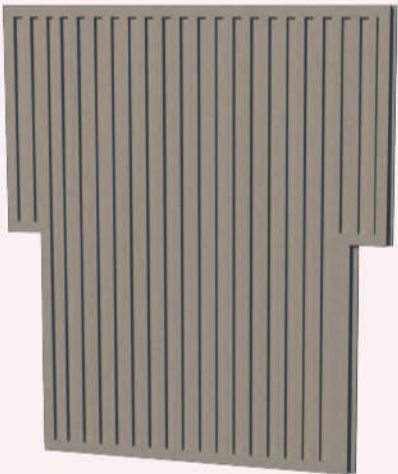

## SECTIONAL DRAWING

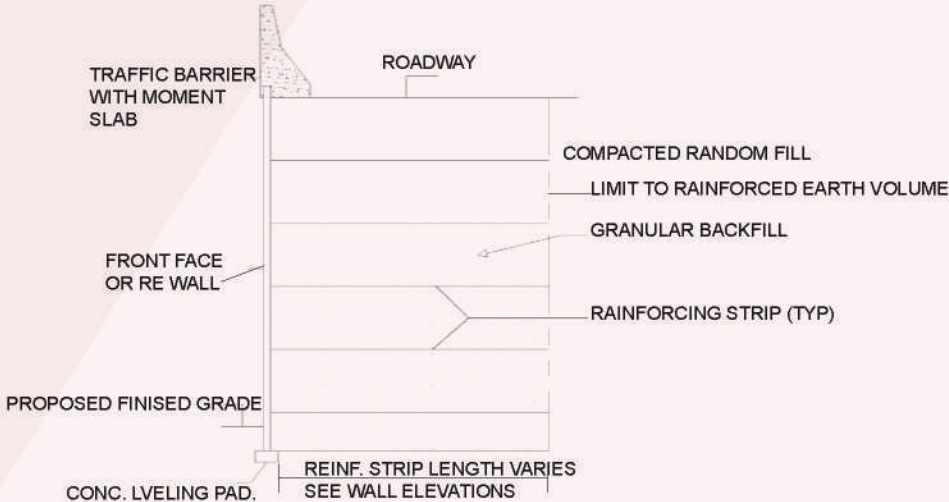

# APPLICATION AREA

Mass gravity walls

Rainforced soil structures

Sea walls

Coastal protection

Erosion prevention

Wing walls

Steam channels

Bridge abutments

Tunnel access walls

Temporary highway slip stabilisation

Embankment stabilisation

Temporary bin storage



## ADVANTAGES

- Ability to withstand very high imposed loadings associated with major retaining wall construction in mine, bridge and highway construction works
- Significant cost advantages over other traditional retaining wall systems in critical applications such as described above
- Aesthetic Appeal
- Rapid Construction

# BEAM SECTION

Precast beams and columns offer a perfect solution for fast track projects as well as for regular projects. Whether for a simple or complex structure, precast beams and columns are flexible enough to suit all architectural and structural criteria.

Standard sections include rectangular shapes, I girders, L sections, inverted T sections, box girders and any other shape designed for low rise and high-rise buildings, car parks, bridges and many other structures.

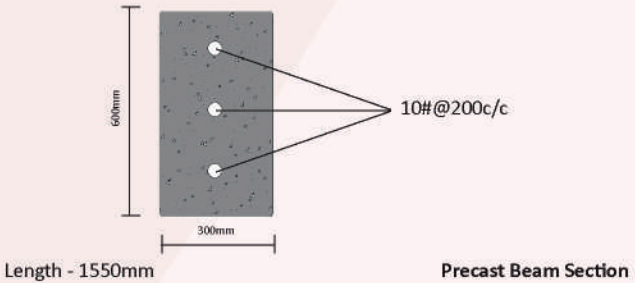
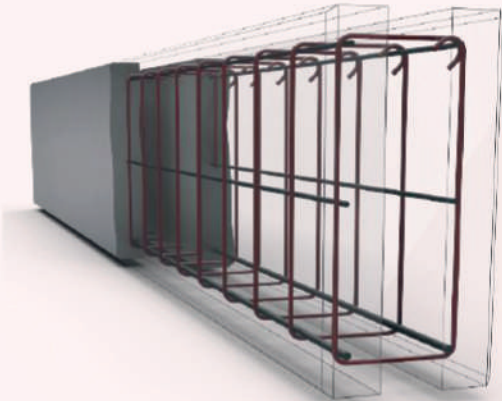
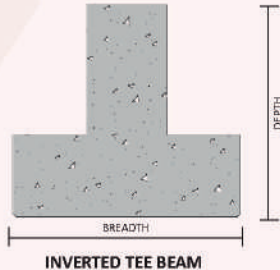
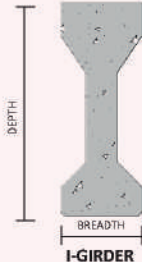
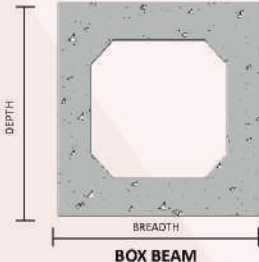
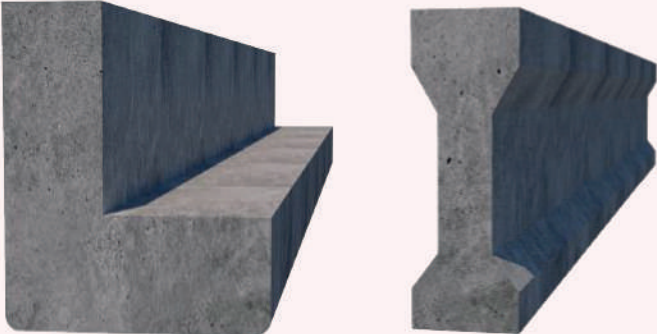

● Other sizes and shapes also available as per requirements

# ADVANTAGES

Easy to install

Quality production

Durability

Design flexibility

Eco - friendly

Economical

Smooth surface finishes



# COMPOUND WALL

Pre-Stress, Pre-Cast Compound Wall is a technology which fulfills the modern requirements of stronger, more durable, lean and economical than traditional boundary wall. Precast concrete technology has proved its worth by saving a lots of construction time. The best part of the technology is that it not only speeds up construction work but also enhances the quality of the final output. By use of this technology can bring down the construction cost by 35-40 % and it could be the answer to affordable creation.

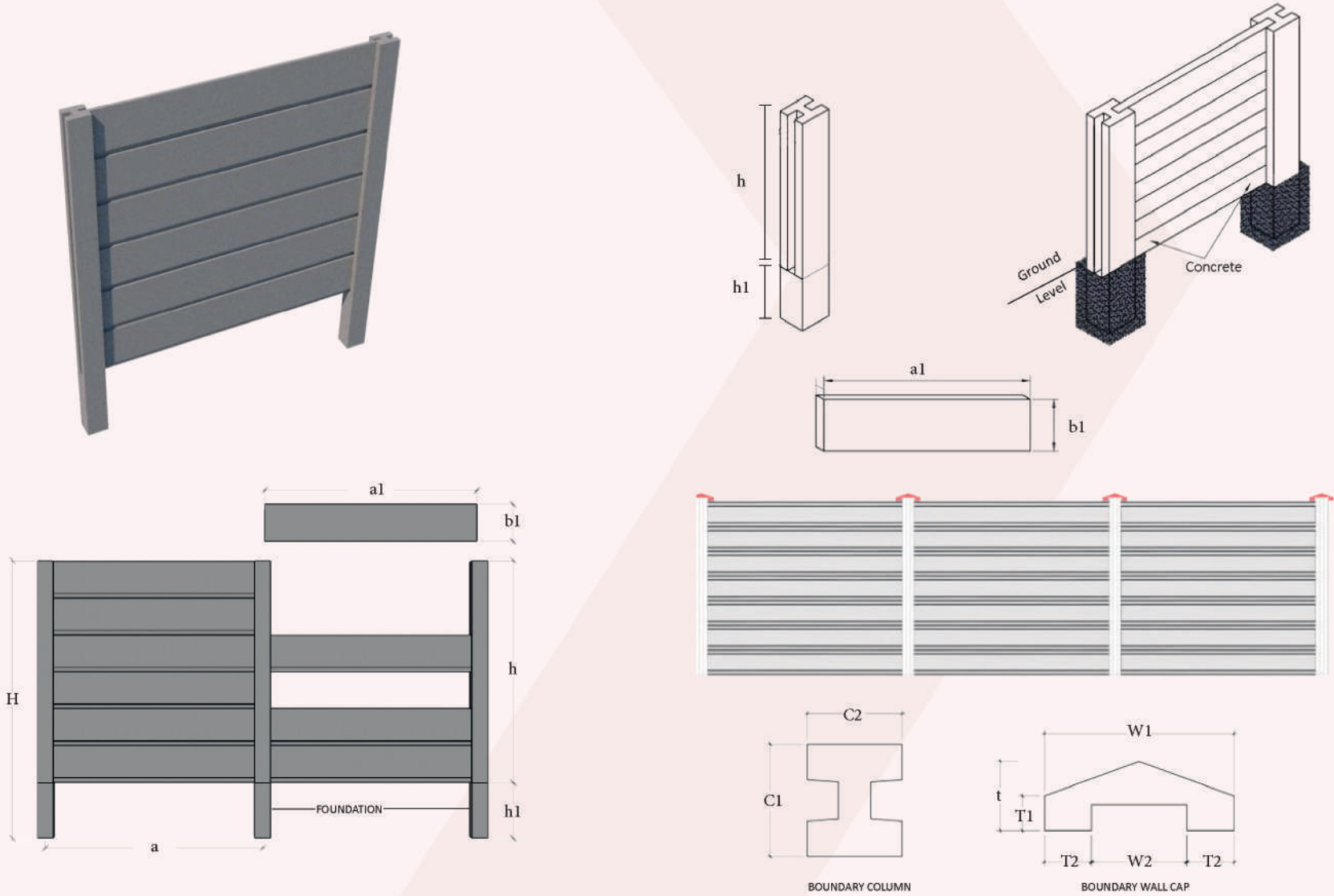

# ADVANTAGES

Ultra high strength

Superior quality

Longer life span

Reliability

Durable

Rapid installation

Less repair & maintenance

Economical



# APPLICATION AREA

- Hotel
- Industrial area
- Parking plots
- Office
- Garden
- Entertainment place

# OUR OTHER PRODUCTS

## PAVERS & KERBSTONE

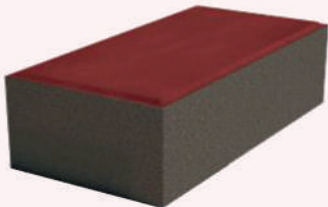

**RECTANGULAR PAVER**  
SIZE-200X100X60mm

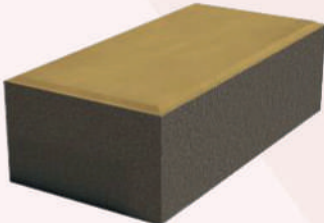

**RECTANGULAR PAVER**  
SIZE-200X100X80mm

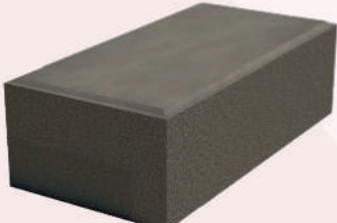

**RECTANGULAR PAVER**  
SIZE-200X100X100mm



**UNI PAVER**  
SIZE-225X112.5X60mm



**UNI PAVER**  
SIZE-225X112.5X80mm



**BIG RECTANGULAR PAVER**  
SIZE-300X200X60mm

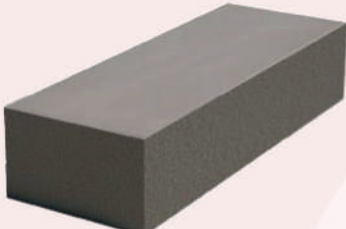

**BRADSTONE PAVER**  
SIZE-275X100X60mm

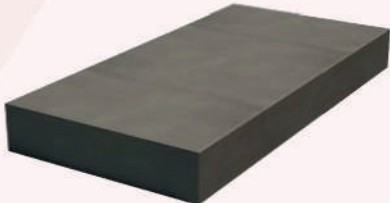

**BIG SLATE PAVER**  
SIZE-550X275X60mm

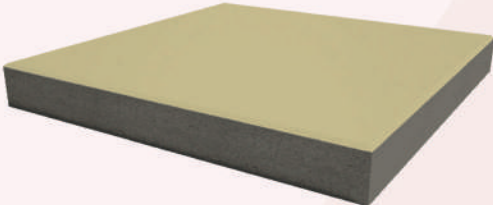

**BIG SQUARE PAVER**  
SIZE - 550x550x150mm



**HALF BATTERED BULL NOSE KERB**  
SIZE - 300x390x150mm

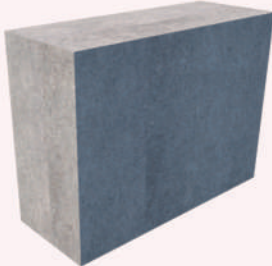

**EDGE KERB (RECTANGULAR)**  
SIZE - 390x290x150mm



# OUR OTHER PRODUCTS

## RUBBER MOULDED PAVERS



**MILANO PAVER**  
218x270x60 mm



**BASIL PAVER**  
232 Block per 100 sq.ft.  
60 mm thickness

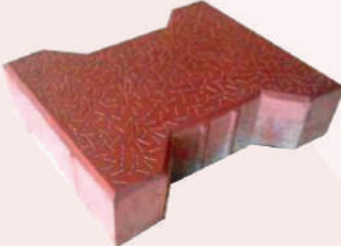

**I SHAPE PAVER**  
SIZE-200X160X60mm



**HEXAGON PAVER**  
SIZE-120X120X60mm



**OXFORD PAVER**  
188 Block per 100 sq.ft.  
60 mm thickness

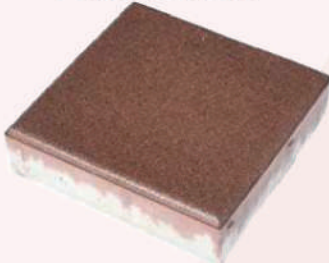

**SQUARE PAVER**  
SIZE-300X300X60mm

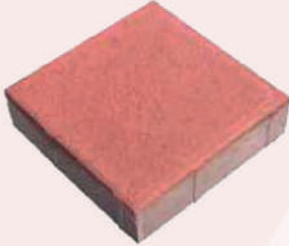

**SQUARE PAVER**  
SIZE-200X200X60mm

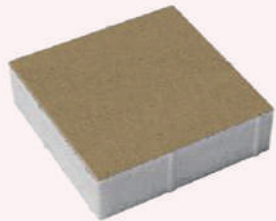

**SQUARE PAVER**  
SIZE-150X150X60mm



**UNI PAVER**  
SIZE-250X123X60mm



**RECTANGULAR PAVER**  
SIZE-200X100X60mm

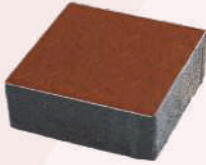

**COBBLE PAVER**  
SIZE-100X100X60mm



**GRASS GRID**  
SIZE-300X300X60mm

**Note:** Rubber moulded paver colours and surface texture can be customised as per requirements (coverage area may vary depending on size & shape).

# OUR OTHER PRODUCTS

## FLY ASH BRICKS & BLOCKS



**FLY ASH BRICK**  
SIZE-225X90X75mm

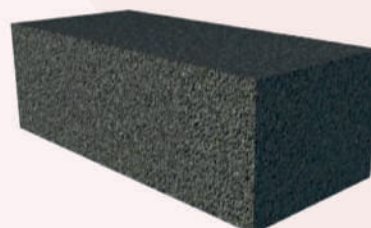

**FLY ASH BRICK**  
SIZE-225X100X75mm

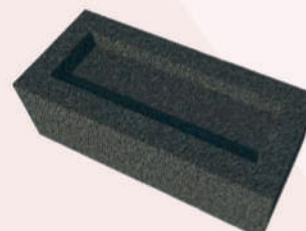

**FLY ASH FROG BRICK**  
SIZE-225X100X75mm

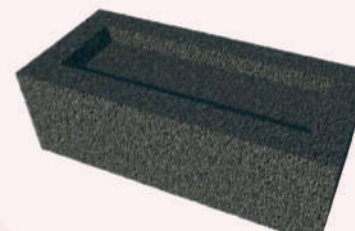

**FLY ASH FROG BRICK**  
SIZE-230X110X75mm

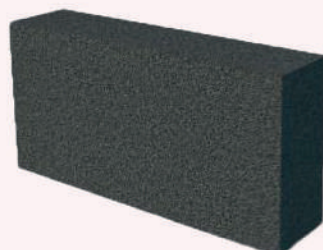

**SOLID BLOCK**  
SIZE-390X190X90mm



**SOLID BLOCK**  
SIZE-400X200X150mm

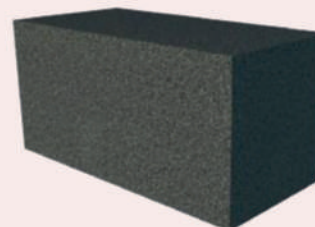

**SOLID BLOCK**  
SIZE-390X190X190mm

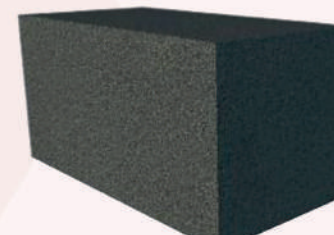

**SOLID BLOCK**  
SIZE-400X200X200mm



**HOLLOW BRICK**  
SIZE-230X110X112.5mm

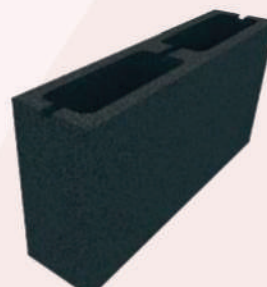

**HOLLOW BLOCK**  
SIZE-390X190X90mm



**HOLLOW BLOCK**  
SIZE-390X190X190mm



**THERMAL INSULATION**

# OUR OTHER PRODUCTS

## FACADE SERIES



**DIMENSION-** L: 120-390m  
W: 50-220m  
T: 25-50mm

**USAGE** - Exterior & Interior wall decoration

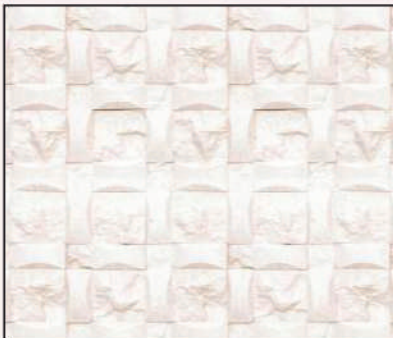

**CREAMY WHITE**  
SIZE - 600X300mm  
THICKNESS - 20mm

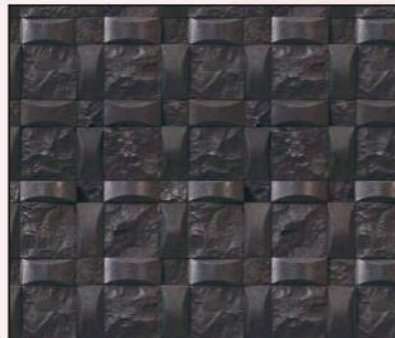

**JET BLACK**  
SIZE - 600X300mm  
THICKNESS - 20mm

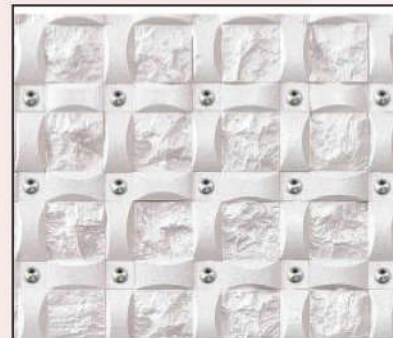

**PURE WHITE**  
SIZE - 600X300mm  
THICKNESS - 20mm

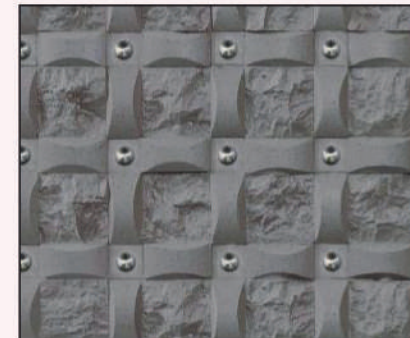

**SILVER GREY**  
SIZE - 600X300mm  
THICKNESS - 20mm

**Note:** Facade panel colour can be customised as per requirements.

**Factory & Head Office:**

**Kankaria Precast Pvt. Ltd.**  
Survey No. 658/2 village Bagodara,  
Near Toll Tax, Limdi Highway  
Bagodara - 382230, Taluka - Bavla,  
Dist. Ahmedabad  
Ph: + 91 9978601839

E-mail: [info@kankariaholdings.in](mailto:info@kankariaholdings.in)  
website: [www.kankariaholdings.in](http://www.kankariaholdings.in)

**Marketing Office:**

**Kankaria Precast Pvt. Ltd.**  
A - 701, Privilon, Behind Iscon temple,  
Near Iscon cross road,  
Bopal Aambli road, Vikaram Nagar,  
Ahmedabad - 380059.  
Ph : + 91 9978601884  
+ 91 9978601839

This brochure is not a legal offering. The information, offerings and specifications are indicative and are subject to change without any prior notice.

**Note:** Above specifications are applicable for standard products. Other specifications are also available as per customer requirement. Actual weight, dimensions and concrete grade may vary. Rubber mould paver colour, dimension, design and surface texture can be customised as per requirements.